

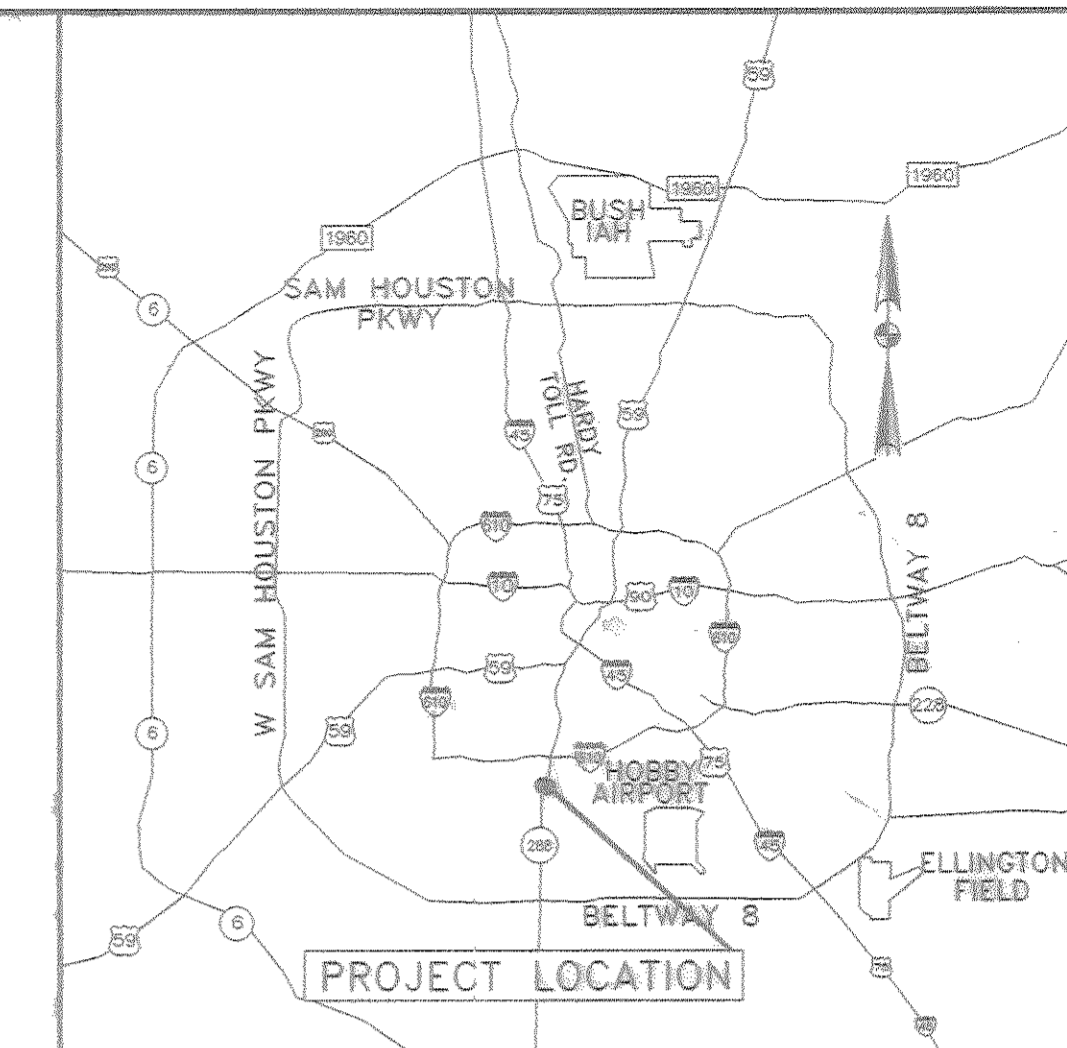

HOUSTON CENTRAL UNIT REPUBLIC '734' WK4734
 PROPOSED CONDUITS ALONG AIRPORT BLVD.
 CROSSING S.H. 288
 HARRIS COUNTY, TEXAS

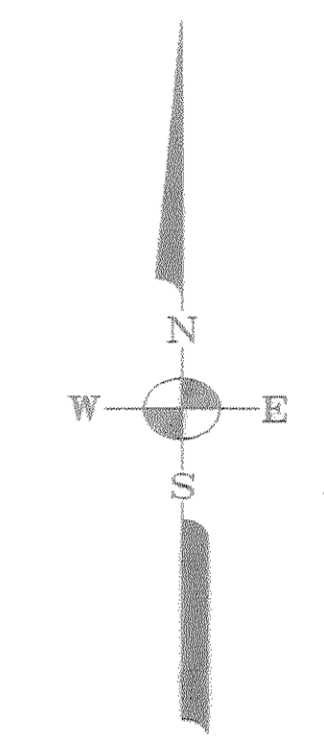

VICINITY MAP
N.T.S.



Key Map # 573E
Gims Map # 5352B

SHEET INDEX	
A	COVER SHEET
B	GENERAL NOTES & SPECIFICATIONS
C	GENERAL NOTES & SPECIFICATIONS
C-1	GENERAL NOTES & SPECIFICATIONS
D	TRAFFIC CONTROL PLAN
R	STREET CUT STANDARDS
101	CONSTRUCTION SHEET
102	CONSTRUCTION SHEET
103	CONSTRUCTION SHEET

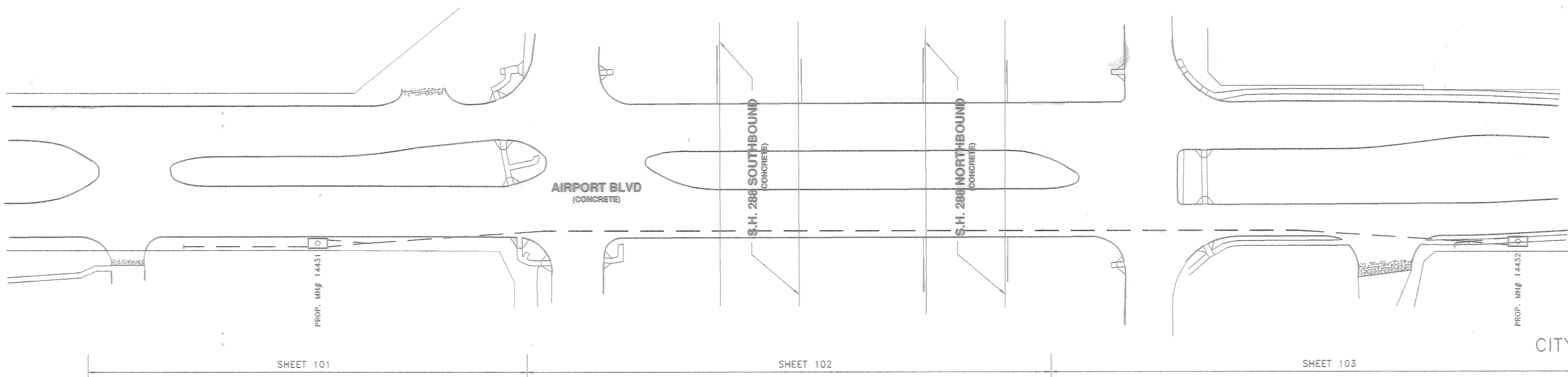

PROJECT MAP
N.T.S.

APPROVED
CITY OF HOUSTON

Brandagiri
CITY ENGINEER
Showri Nandagiri, P.E. 3/21/03
DATE

Jon C. Vanden Bosch
DIRECTOR OF PUBLIC WORKS & ENGINEERING
Jon C. Vanden Bosch, P.E. 3/20/2003
DATE



TXDOT PERMIT No. 03-00		COH Log No. 03-0177		DWG. 603-001	
PROJECT NO.	5067876	DATE ISSUED		NUMBER OF SHEETS	9
AREA NO.	WK4734				

THIS PROJECT HAS BEEN DETERMINED TO BE OUTSIDE THE 100-YEAR FLOOD PLAN AND IS IN ZONES X, AS SHOWN ON ABOVE VICINITY MAP, ACCORDING TO THE FIRM MAP NUMBER 48201C0880 K, REVISED APRIL 20, 2000 PANEL 880 OF 1135.

RE-W4-1-00



PROP. CONDUITS ALONG AIRPORT @ S.H. 288

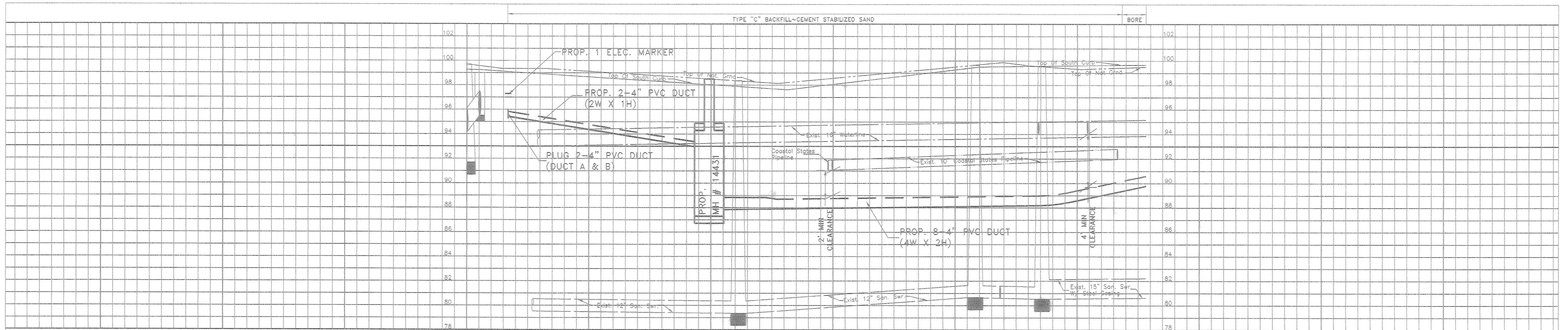

THIS APPROVAL IS FOR CONSTRUCTION UTILIZING AUGER / BORE AND JACK METHOD ONLY. FOR ANY REASONS, IF OPEN CUT METHOD IS REQUIRED, APPROPRIATE PAVEMENT RESTORATION TYPICAL SHEET SHALL BE SUBMITTED FOR REVIEW AT LEAST 48 HOURS IN ADVANCE BEFORE STARTING CONSTRUCTION. THESE RESTORATIONS TYPICAL SHALL BE DRAWN ON MYLAR SEALED, SIGNED, AND DATED BY A PROFESSIONAL ENGINEER IN THE STATE OF TEXAS.

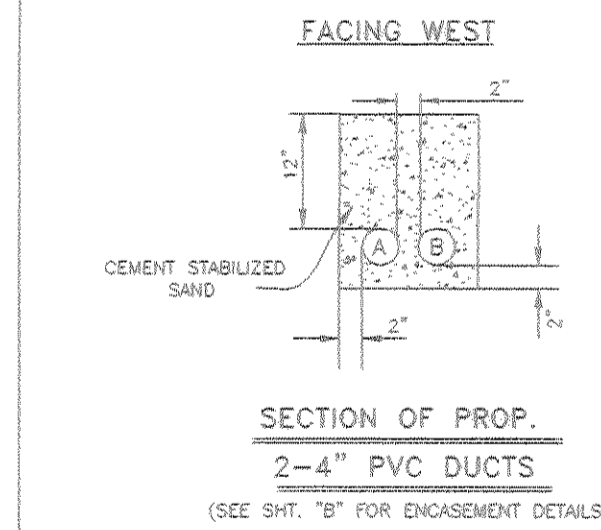
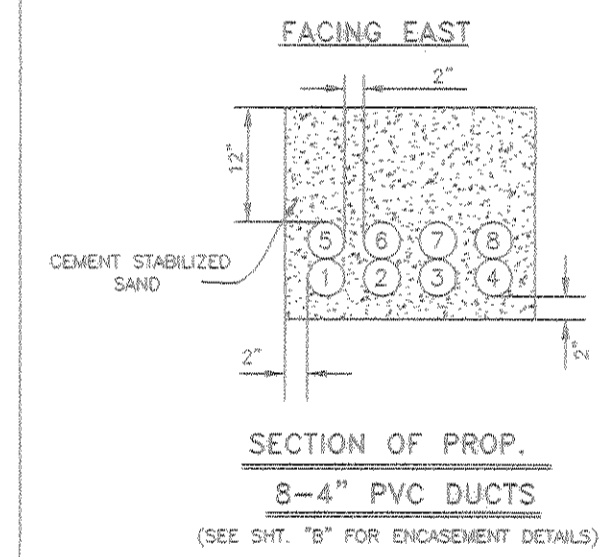

NOTIFY COASTAL STATE @ 1-800-895-2396 AT LEAST TWO WORKING DAYS PRIOR TO COMMENCING WORK NEAR COASTAL'S PIPELINE.

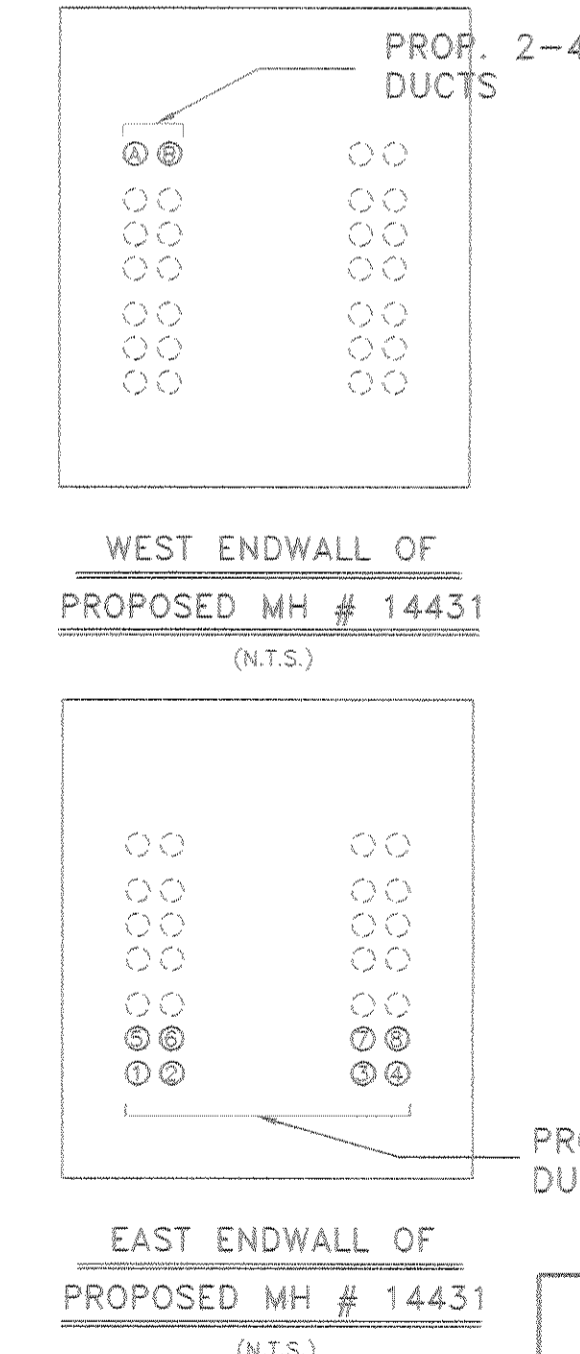
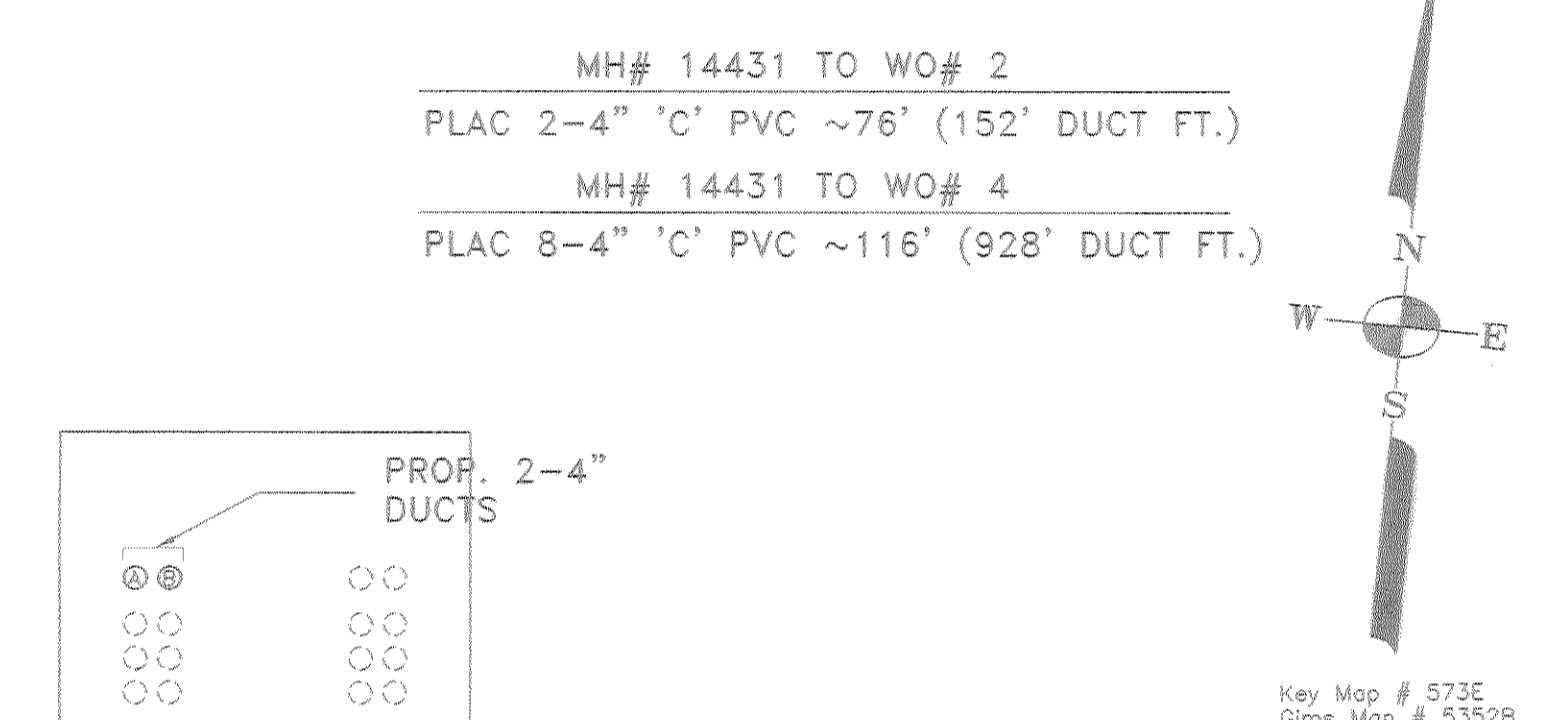
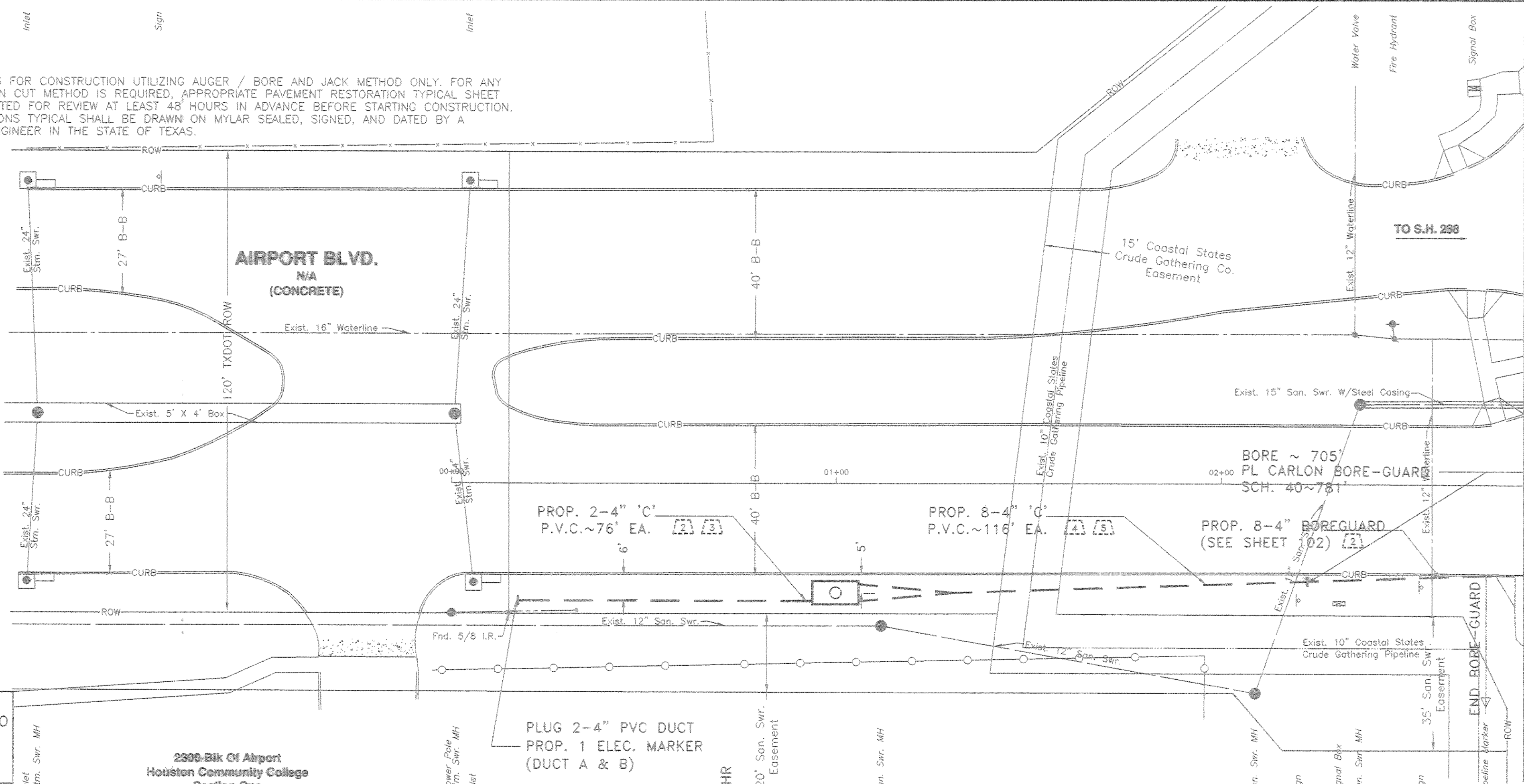

CITY OF HOUSTON
DEPARTMENT OF PUBLIC WORKS AND ENGINEERING

REVIEWED BY: *[Signature]* PROJECT MANAGER
 13.26.03
[Signature] CHIEF ENGINEER
 13.26.03
[Signature] SPONSOR DEPARTMENT

3-20-03
[Signature] CITY ENGINEER
 3/20/03
[Signature] DIRECTOR OF PUBLIC WORKS AND ENGINEERING

OPER. RANGE	ACTION CODE	MAJOR MATERIAL DESCRIPTION	ACCT. CODE	ML OR AMT.	PL	BORE	REMOVALS AMOUNT	WORT. DATE
1	PLAC	MANHOLE	4C			1		
2	PLAC	TRENCH-2-MPC	4C	76'				
3	PLAC	PVC-C-4", 2	4C			152'		
4	PLAC	TRENCH-8-MPC	4C	116'				
5	PLAC	PVC-C-4", 8	4C			928'		

PROP. MH# 14431
 6' 01+00, 28' RT
 12'-0" X 6'-0" X 7'-0" HR
 VOL. = 504 CU. FT.
 PL 1-30' F&C TYP.
 95°W 23' 08.61686"
 29°N 38' 16.78743"

PROP MH # 14431 TO PROP MH # 14432
 967 C-C 955 W-W

TEMPORARY BENCH MARK
 P.K. NAIL SET IN MEDIAN OF AIRPORT BLVD.
 LOCATED 137' EAST OF THE NORTHBOUND OVERPASS
 OF S.H. 288. (STA. 07+85, 27' LT)
 ELEV. = 100.00

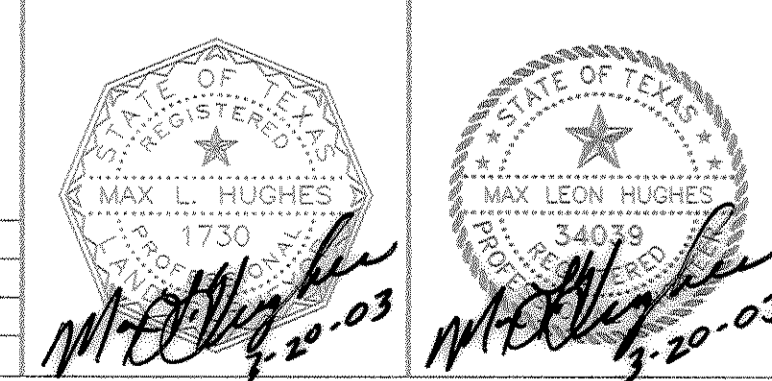

PROPOSED DUCTS ALONG
 AIRPORT BLVD CROSSING S.H.288

SCALE: PLAN 1" = 20' PROFILE VERT. 1" = 4' PROFILE HORZ. 1" = 20'

C.P.# 603-001

PREPARED BY: *[Signature]* *[Signature]*
 CONDUIT DISTRICT: J.S. DATE: 3/20/03

PROJECT NO. 5087876 REC REF N/A SHEET 101
 AREA NO. WK4734 C.O. REPUBLIC 734 TAX DIST. HGO31

SEE CONSTRUCTION NOTES & DETAILS ON B, C & D SHEETS

RE-W4-1-01

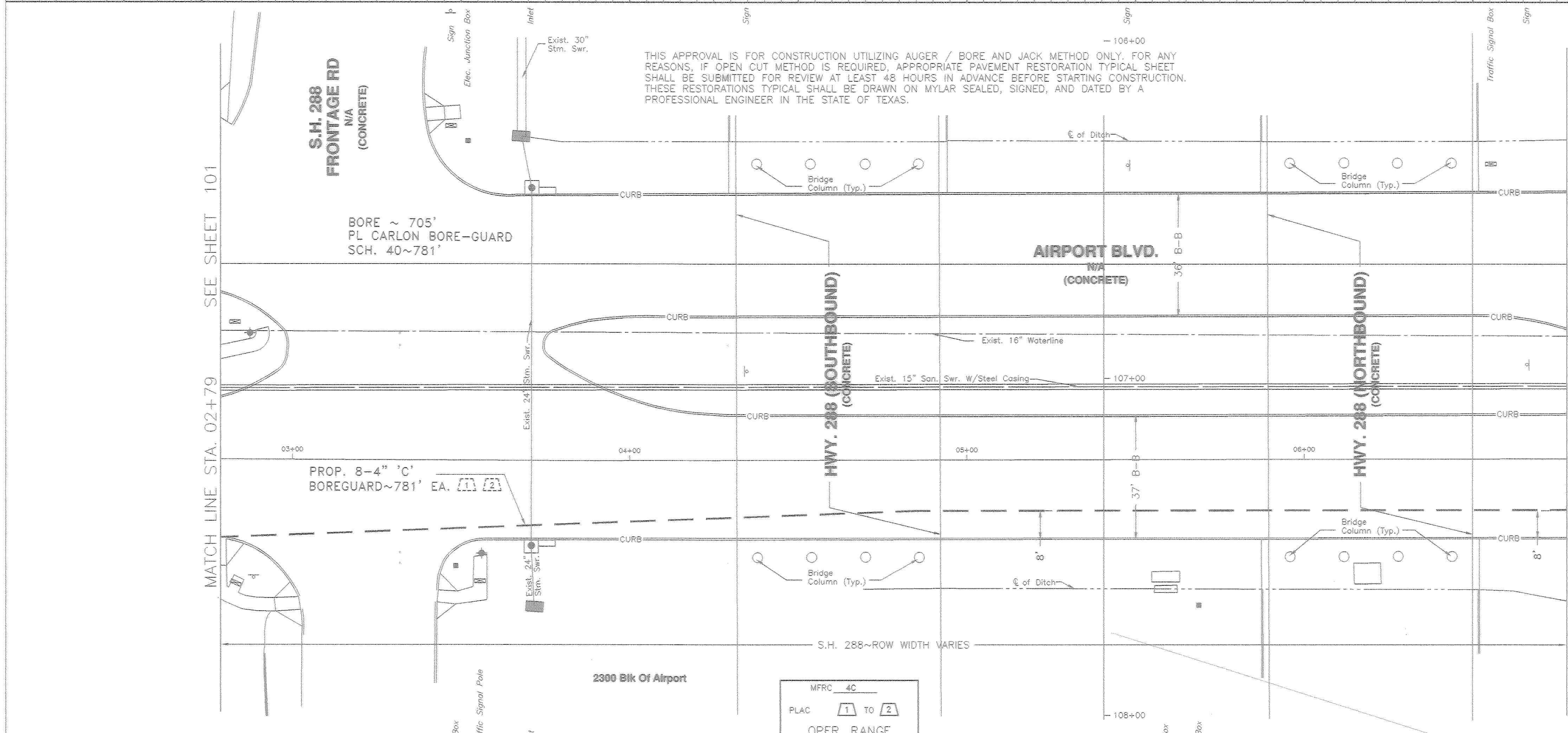
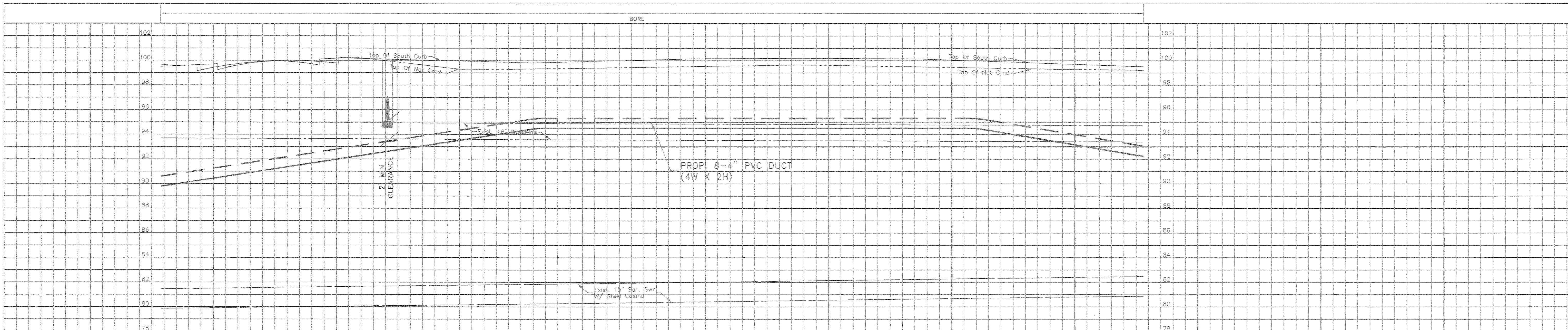

THIS APPROVAL IS FOR CONSTRUCTION UTILIZING AUGER / BORE AND JACK METHOD ONLY. FOR ANY REASONS, IF OPEN CUT METHOD IS REQUIRED, APPROPRIATE PAVEMENT RESTORATION TYPICAL SHEET SHALL BE SUBMITTED FOR REVIEW AT LEAST 48 HOURS IN ADVANCE BEFORE STARTING CONSTRUCTION. THESE RESTORATIONS TYPICAL SHALL BE DRAWN ON MYLAR SEALED, SIGNED, AND DATED BY A PROFESSIONAL ENGINEER IN THE STATE OF TEXAS.

WO# 4 (SEE SHEET 101) TO WO# 6 (SEE SHEET 103)
 PLAC 8-4" BOREGUARD ~781' (6248' DUCT FT.)

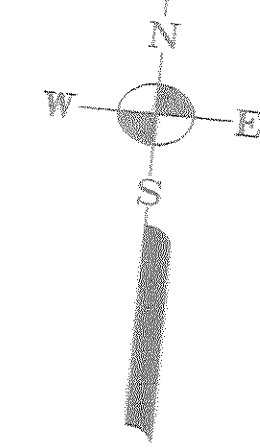
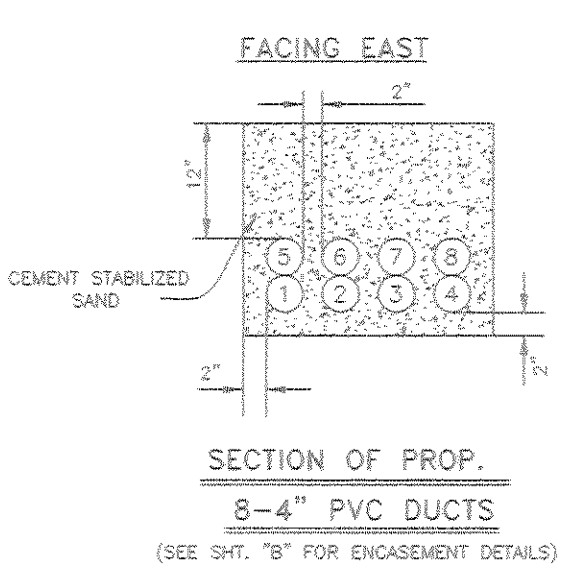

Key Map # 573E
 Gims Map # 5352B

CITY OF HOUSTON DEPARTMENT OF PUBLIC WORKS AND ENGINEERING	
REVIEWED BY <i>John E. Brown</i>	CITY FUNDED PUBLIC WORKS
WATER <i>John E. Brown</i>	PROJECT MANAGER
WASTEWATER <i>Samuel Hughes</i>	CONSTRUCTION
STORM WATER <i>Samuel Hughes</i>	CHIEF ENGINEER
STREET & B.P. USE <i>Samuel Hughes</i>	OTHER APPROVAL
TRAFFIC AND TRANSPORTATION <i>Samuel Hughes</i>	SPONSOR DEPARTMENT
CITY ENGINEER <i>Samuel Hughes</i>	DATE 3/20/03
DIRECTOR OF PUBLIC WORKS AND ENGINEERING <i>Samuel Hughes</i>	DATE 3/20/03

PROPOSED DUCTS ALONG
AIRPORT BLVD CROSSING S.H.288

SCALE: PLAN 1" = 20'	PROFILE VERT. 1" = 4'	PROFILE HORIZ. 1" = 20'
C.P.# 603-001	PREPARED BY <i>Richy Brown</i>	DRAWN BY <i>John E. Brown</i>
PROJECT NO. 5067876	REC REF	N/A
AREA NO. WK4734	C.O. REPUBLIC 734	TAX DIST. HGO31
SHEET 102		J.S.

OPER	ACTION CODE	MAJOR MATERIAL DESCRIPTION	ACCT. CODE	ML OR AMT.	PL	BORE	REMOVALS
							AMOUNT
1	PLAC	TRENCH-S	4C	781'		781'	
2	PLAC	PVC-C-4", 8	4C	6248'			

(BOREGUARD)

TEMPORARY BENCH MARK
 P.K. NAIL SET IN MEDIAN OF AIRPORT BLVD.
 LOCATED 137' EAST OF THE NORTHBOUND OVERPASS
 OF S.H. 288. (STA. 07+85, 27.7' LT)
 ELEV. = 100.00

SEE CONSTRUCTION NOTES & DETAILS ON B, C & D SHEETS

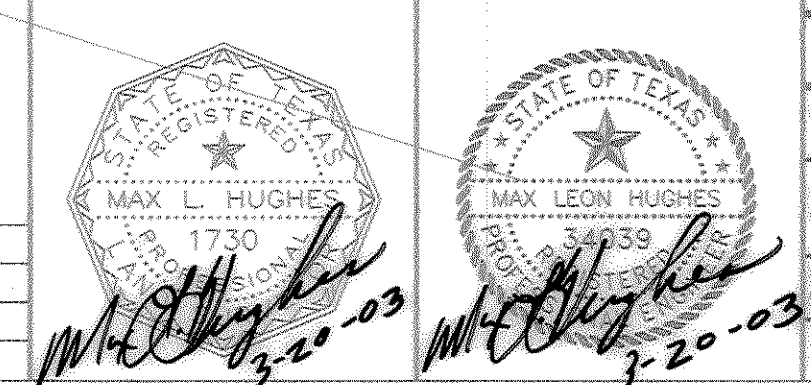

RE-W4-1-02

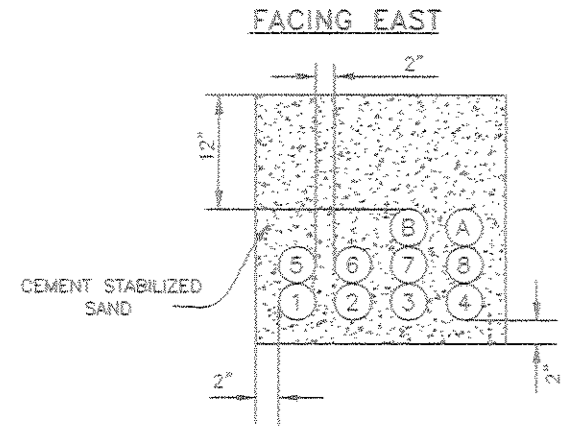
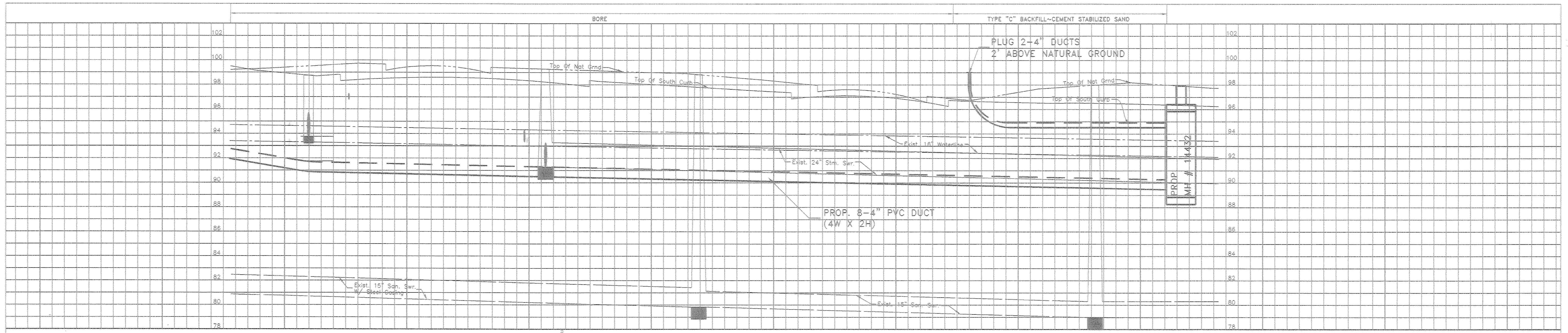

SECTION OF PROP. 10-4" PVC DUCTS
(SEE SHT. "B" FOR ENCASUREMENT DETAILS)

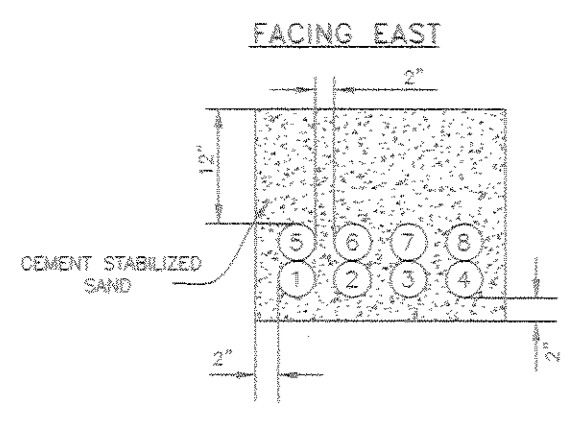

SECTION OF PROP. 8-4" PVC DUCTS
(SEE SHT. "B" FOR ENCASUREMENT DETAILS)

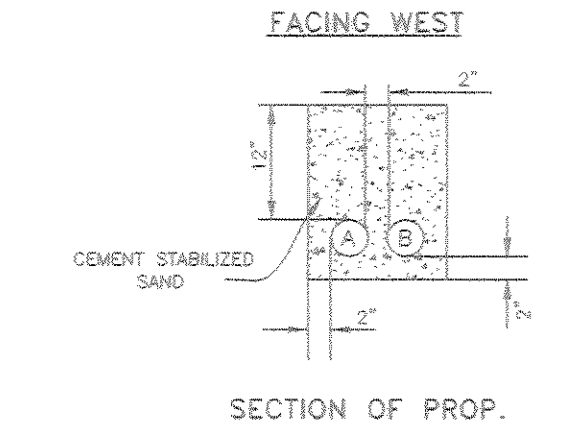

SECTION OF PROP. 2-4" PVC DUCTS
(SEE SHT. "B" FOR ENCASUREMENT DETAILS)

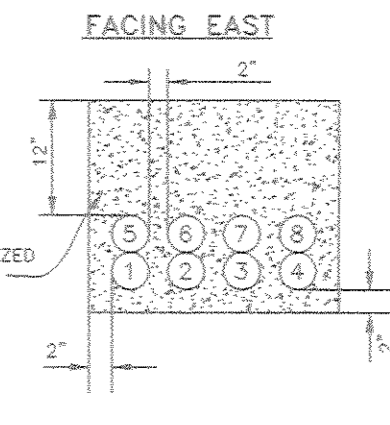
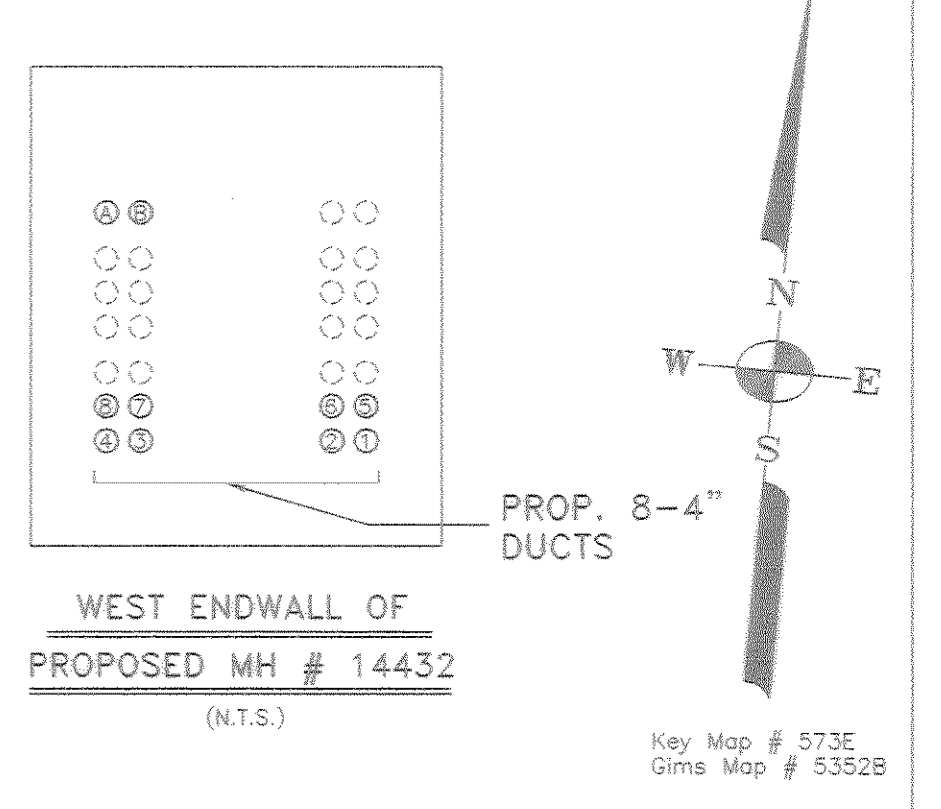
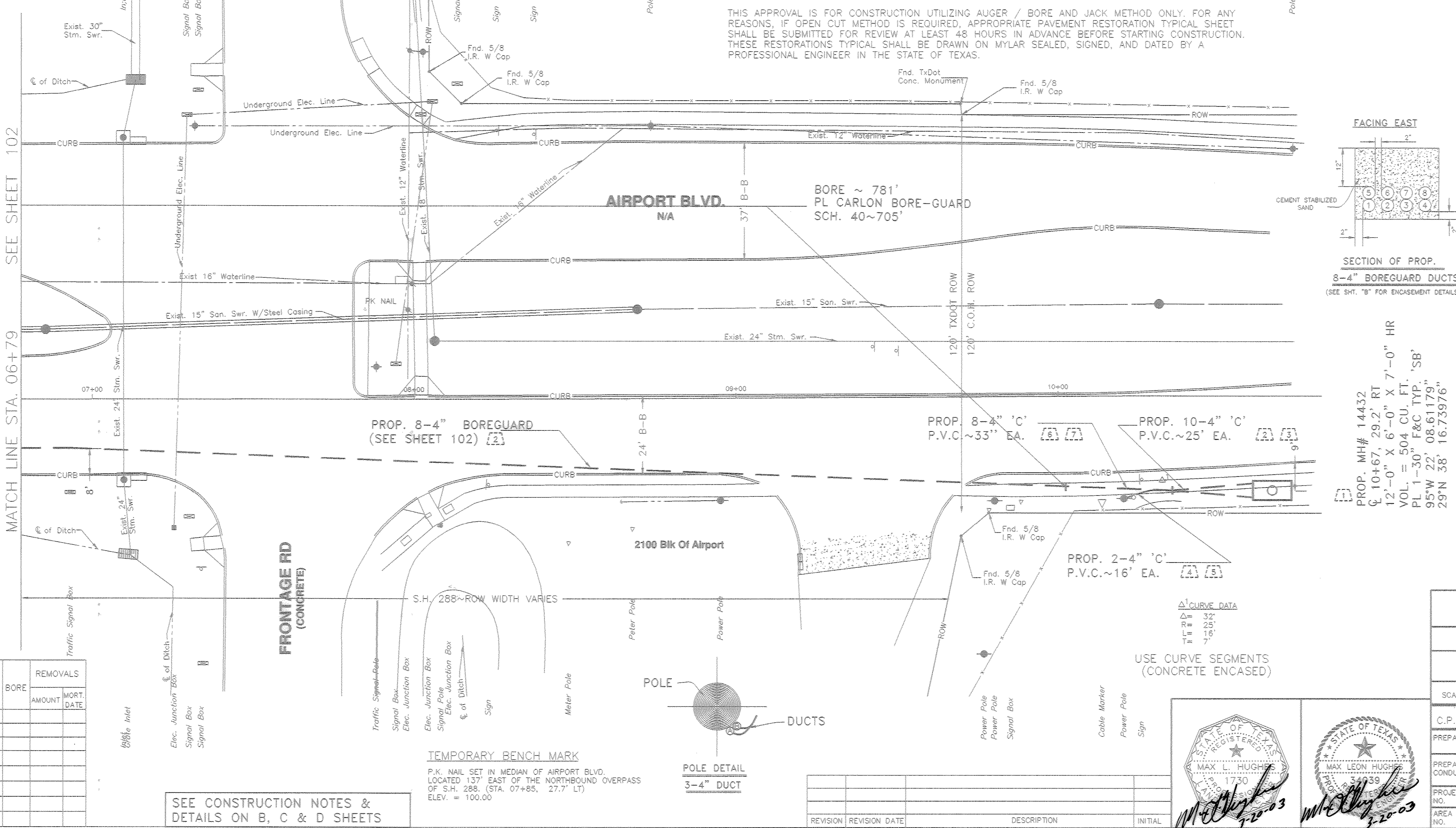

SECTION OF PROP. 8-4" BOREGUARD DUCTS
(SEE SHT. "B" FOR ENCASUREMENT DETAILS)

PROP. MH# 14432
 10'-0" X 29'-2" RT
 12'-0" X 6'-0" X 7'-0" HR
 VOL = 504 CU. FT.
 PL 1-30" F&C TYP. 'SB'
 95'W 22' 08.61179"
 29'N 38' 16.73976"

CITY OF HOUSTON
 DEPARTMENT OF PUBLIC WORKS AND ENGINEERING

REVIEWED BY: *[Signature]* PROJECT MANAGER
 WATER: *[Signature]* 3-20-03
 WASTEWATER: *[Signature]* 3-20-03
 STORM WATER: *[Signature]* 3-20-03
 STREET & BRIDGE: *[Signature]* 3-20-03 CHIEF ENGINEER
 OTHER APPROVAL: *[Signature]* 3-20-03
 TRAFFIC AND TRANSPORTATION: *[Signature]* 3/20/03 SPONSOR DEPARTMENT

CITY ENGINEER: *[Signature]* 3/20/03
 DIRECTOR OF PUBLIC WORKS AND ENGINEERING: *[Signature]* 3/20/03

PROPOSED DUCTS ALONG		
AIRPORT BLVD CROSSING S.H.288		
SCALE: PLAN 1" = 20'	PROFILE VERT. 1" = 4'	PROFILE HORIZ. 1" = 20'
C.P.# 603-001	PREPARED BY: <i>[Signature]</i>	DRAWN BY: <i>[Signature]</i>
CONDUIT DISTRICT: MGR-ENG DESIGN	REC REF: N/A	ISSUE DATE: J.S.
PROJECT NO. 5067876	TAX DIST. HGO31	SHEET 103
AREA NO. WK4734	C.O. REPUBLIC 734	JOB # FTH02656

OPER	ACTION CODE	MAJOR MATERIAL DESCRIPTION	ACCT. CODE	ML OR AMT.	PL	BORE	REMOVALS
						AMOUNT	MORT. DATE
1	PLAC	MANHOLE	4C		1		
2	PLAC	TRENCH-10-MPC	4C	25'			
3	PLAC	PVC-C-4", 10	4C		250'		
4	PLAC	TRENCH-2-MPC	4C	16'			
5	PLAC	PVC-C-4", 2	4C		32'		
6	PLAC	TRENCH-8-MPC	4C	33'			
7	PLAC	PVC-C-4", 8	4C		264'		

SEE CONSTRUCTION NOTES & DETAILS ON B, C & D SHEETS

TEMPORARY BENCH MARK
 P.K. NAIL SET IN MEDIUM OF AIRPORT BLVD.
 LOCATED 137' EAST OF THE NORTHBOUND OVERPASS
 OF S.H. 288. (STA. 07+85, 27.7' LT)
 ELEV. = 100.00

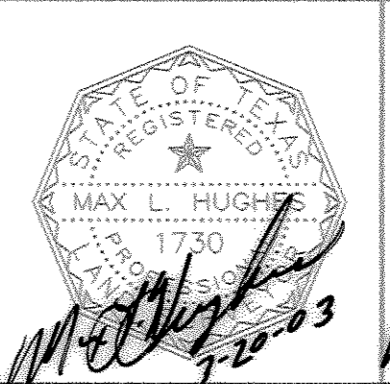
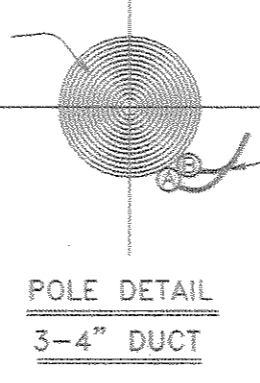

RE-W4-1-03