

Part 8

Traffic Control for Railroad and Light Rail Transit Grade Crossings



Texas MUTCD

Texas Manual on Uniform Traffic Control Devices

PART 8

TRAFFIC CONTROL FOR RAILROAD AND LIGHT RAIL TRANSIT GRADE CROSSINGS

CHAPTER 8A. GENERAL

Section 8A.01 Introduction

Support:

- 01 Where the acronym “LRT” is used in Part 8, it refers to “light rail transit.”
- 02 Chapters 8A, 8B, 8C, and 8D describe the traffic control devices that are used at highway-rail and highway-LRT grade crossings. Unless otherwise provided in the text or on a figure or table, the provisions of Part 8 are applicable to both highway-rail and highway-LRT grade crossings. Where the phrase “grade crossing” is used by itself without the prefix “highway-rail” or “highway-LRT,” it refers to both highway-rail and highway-LRT grade crossings.
- 03 Chapter 8E describes the traffic control devices that are used at pathway and sidewalk grade crossings.
- 04 Traffic control for grade crossings includes all signs, signals, markings, other warning devices, and their supports along highways approaching and at grade crossings. The function of this traffic control is to promote safety and provide effective operation of rail and/or LRT and highway traffic at grade crossings.
- 05 For purposes of design, installation, operation, and maintenance of traffic control devices at grade crossings, it is recognized that the crossing of the highway and rail tracks is situated on a right-of-way available for the joint use of both highway traffic and railroad or LRT traffic.
- 06 Grade crossings and the traffic control devices that are associated with them are unique in that in many cases, the highway agency or authority with jurisdiction, the regulatory agency with statutory authority (if applicable), and the railroad company or transit agency are jointly involved in the development of engineering judgment or the performance of an engineering study. This joint process is accomplished through the efforts of a Diagnostic Team made up of the highway agency with jurisdiction, the regulatory agency with statutory authority (if applicable), and the railroad company and/or transit agency (if applicable).
- 07 In Part 8, the combination of traffic control devices selected or installed at a specific grade crossing is referred to as a “traffic control system.”
- 08 The combination of railroad or LRT active traffic control devices used to inform road users at a grade crossing of the approach or presence of rail traffic and the necessary control equipment for the devices are referred to as a “grade crossing warning system.” The “2023 AREMA Communications and Signals Manual” published by the American Railway Engineering and Maintenance-of-Way Association (AREMA) contains further information about grade crossing warning systems.

Standard:

- 09 **Except at grade crossings of privately-owned roadways, pathways, and sidewalks, the traffic control devices, systems, and practices described in this Manual shall be used at all grade crossings open to public travel, consistent with Federal, State, and local laws and regulations.**

Support:

- 10 23 CFR 655.603 contains information on the applicability of this Manual at private grade crossings.

Section 8A.02 Highway-LRT Grade Crossings

Support:

- 01 Part 8 also describes the traffic control devices that are used in locations where light rail transit (LRT) vehicles are operating along streets and highways in mixed traffic with road users.
- 02 LRT is a mode of public transportation that employs LRT vehicles (commonly known as light rail vehicles, streetcars, or trolleys) that operate on rails in streets in mixed traffic, and LRT traffic that operates in semi-exclusive rights-of-way, or in exclusive rights-of-way. Where the phrase “LRT” is used in Part 8, it refers to light rail vehicles, streetcars, and trolleys. Grade crossings with LRT can occur at intersections or at midblock locations, including public and private driveways.
- 03 An initial educational campaign along with an ongoing program to continue to educate new drivers is beneficial when introducing LRT operations to an area and, hence, new traffic control devices.
- 04 LRT alignments can be grouped into one of the following three types (see definitions in Section 1C.02):
- A. Exclusive: An LRT right-of-way that is grade-separated or protected by a fence or traffic barrier. Motor vehicles, pedestrians, and bicycles are prohibited within the right-of-way. This type of alignment does not have grade crossings and is not further addressed in Part 8.

- B. Semi-exclusive: An LRT alignment that is in a separate right-of-way or along a street or railroad right-of-way where motor vehicles, pedestrians, and bicyclists have limited access and cross at designated locations only, such as at grade crossings where road users must yield the right-of-way to the light rail transit traffic.
- C. Mixed-use: An alignment where LRT operates in mixed traffic with all types of road users. In a mixed-use alignment, the light rail transit traffic does not have the right-of-way over other road users at grade crossings and intersections. If the LRT traffic is controlled by traffic control signals or LRT signal faces at an intersection with a roadway, the alignment is considered to be mixed-use even if some of the approaches to the intersection are used exclusively by LRT traffic.

Guidance:

- 05 *If a highway-LRT grade crossing is equipped with flashing-light signals and is located 200 feet or less from an intersection or midblock location controlled by a traffic control signal or a pedestrian hybrid beacon, the intersection should be provided with rail preemption in accordance with Sections 4F.19 and 8D.09 unless otherwise determined by the Diagnostic Team.*

Option:

- 06 Where LRT vehicles are operating in a mixed-use alignment, traffic signal priority or preemption may be used as determined by a Diagnostic Team.

Standard:

- 07 **Where LRT and railroads use the same tracks or adjacent tracks, the traffic control devices, systems, and practices for highway-rail grade crossings shall be used.**

Section 8A.03 Traffic Control Systems and Practices at Grade Crossings

Support:

- 01 Because of the large number of significant variables to be considered, no single standard system of traffic control devices is universally applicable for all grade crossings.

Standard:

- 02 **Before any new grade crossing traffic control system is installed or before modifications are made to an existing system, approval shall be obtained from the highway agency with jurisdiction, the regulatory agency with statutory authority (if applicable), and the railroad company and/or transit agency.**
- 03 **The Diagnostic Team members shall make a recommendation, documented in an engineering study (see Section 8A.05), on new grade crossing traffic control systems and on proposed changes to an existing grade crossing traffic control system. The Diagnostic Team recommendation shall be made based on the Diagnostic Team’s site visits, meetings, conference calls, or a combination of some or all of these methods.**
- 04 **Except as provided in Paragraph 7 of this Section, operational changes made to a grade crossing traffic control system shall be evaluated by a Diagnostic Team.**
- 05 **Among the types of changes at a grade crossing for which a Diagnostic Team shall conduct an engineering study are: additions, removals, or modifications of the lanes approaching or traversing the grade crossing; addition or removal of tracks; significant changes in the number or speed of trains; significant changes in the number or speed of vehicles; addition of vehicle access near the grade crossing; additions or modifications to sidewalks; additions or modifications to bicycle lanes, especially if a counter-flow bicycle lane is added on a one-way street; changes to roadway use, including conversion to or from one-way operation or reversible lanes; and the installation of or significant operational changes to traffic control signals that might affect the grade crossing.**

Option:

- 06 A Diagnostic Team may conduct an engineering study and make recommendations as part of the Quiet Zone establishment process (see Section 8A.11).
- 07 Where determined by the responsible public agency, the railroad company, and/or the transit agency, general maintenance activities or minor operational changes to the grade crossing traffic control system that do not have a negative impact on the overall operation of the traffic control system may be made without a review and determination by a Diagnostic Team.

Support:

- 08 Many other details of grade crossing traffic control systems that are not set forth in Part 8 are contained in publications such as the “2023 AREMA Communications and Signals Manual” published by the American Railway Engineering and Maintenance-of-Way Association (AREMA), the Third Edition of “Highway-Rail

Crossing Handbook” published by the FHWA and the FRA, and the 2nd Edition of “Preemption of Traffic Signals Near Railroad Crossings” published by the Institute of Transportation Engineers (ITE).

Section 8A.04 Traffic Control Systems at Highway-LRT Grade Crossings

Support:

- 01 The combination of devices selected or installed at a specific highway-LRT grade crossing is referred to as a “Light Rail Transit Traffic Control System.”
- 02 The normal rules of the road and traffic control priority (see [Texas Transportation Code, Subtitle C](#)) govern the order assigned to the movement of vehicles at an intersection unless the local agency determines that it is appropriate to assign a higher priority to LRT vehicles. Examples of different types of LRT priority control include separate traffic control signal phases for LRT movements, restriction of movement of roadway vehicles in favor of LRT operations, and preemption of highway traffic signal control to accommodate LRT movements.

Standard:

- 03 **Highway-LRT grade crossings in semi-exclusive alignments outside of a roadway shall be equipped with flashing-light signals, with or without automatic gates, unless a Diagnostic Team determines that the use of Crossbuck Assemblies, STOP signs, or YIELD signs alone would be adequate.**

Section 8A.05 Engineering Studies at Grade Crossings

Standard:

- 01 **The appropriate traffic control system to be used at a grade crossing shall be determined based on an engineering study conducted by a Diagnostic Team involving the highway agency with jurisdiction, the regulatory agency with statutory authority (if applicable), and the railroad company and/or transit agency (as applicable).**

Option:

- 02 The regulatory agency with statutory authority (if applicable) may approve the grade crossing traffic control system.

Guidance:

- 03 *Among the factors that should be considered in the determination by a Diagnostic Team of which traffic control devices would be appropriate to install at a grade crossing are road geometrics, stopping sight distance, clearing sight distance, the proximity of nearby roadway intersections (including the traffic control devices at the intersections), adjacent driveways, traffic volume across the grade crossing, extent of queuing upstream or downstream from the grade crossing, train volume, pedestrian and bicycle volumes, operation of passenger trains, presence of nearby passenger station stops, maximum allowable train speeds, variable train speeds, accelerating and decelerating trains, multiple tracks, high-speed train operation, number of school buses or hazardous material haul vehicles, and the crash history at or near the location.*

Option:

- 04 The engineering study may include the Highway-Rail Intersection (HRI) components of the National Intelligent Transportation Systems (ITS) architecture, which is a USDOT accepted method for linking the highway, vehicles, and traffic management systems with rail operations and wayside equipment.

Support:

- 05 More detail on Highway-Rail Intersection components is available from the USDOT’s Federal Railroad Administration, 1200 New Jersey Avenue, SE, Washington, DC 20590, or www.fra.dot.gov.

Section 8A.06 Uniform Provisions

Standard:

- 01 **All signs used in grade crossing traffic control systems shall be retroreflective or illuminated as described in Section 2A.21 to show the same shape and similar color to an approaching road user during both day and night.**
- 02 **No sign or signal shall be located in the center of an undivided highway, unless it is crashworthy (breakaway, yielding, or shielded with a longitudinal barrier or crash cushion) or unless it is placed on a raised island. [Post-mounted sign and object marker supports placed on a raised island shall be crashworthy \(see Section 1D.11\) if within the clear zone.](#)**

Guidance:

- 03 *Any signs or signals placed on a raised island in the center of an undivided highway should be installed with a clearance of at least 2 feet from the outer edge of the raised island to the nearest edge of the sign or signal, except as permitted in Section 2A.16.*
- 04 *Where a raised median island is installed supplemental to an automatic gate to discourage road users from driving around a lowered gate **or due to mechanical limitations of railroad equipment**, the Diagnostic Team should consider the length of the vehicle queues that typically form on the approach to the grade crossing when determining how far in advance of the grade crossing to extend the island.*
- 05 *If the roadway at a grade crossing includes a two-way left-turn lane (see Section 3B.05), the two-way left-turn lane should be discontinued in the immediate vicinity of the grade crossing by installing median islands, by designating the lane for left turns in one direction only, or by installing yellow diagonal markings in the lane (see Figure 3B-5). If yellow diagonal markings are used, the use of channelizing devices (see Section 3I.01), such as supplemental tubular markers, should also be considered.*

Option:

- 06 If yellow diagonal markings are used, extending the automatic gate across the lane may be considered.

Section 8A.07 Minimum Track Clearance Distance and Clear Storage Distance*Support:*

- 01 The upstream point of the minimum track clearance distance is determined in the following manner:
- A. If an automatic gate is present on the approach, the upstream point is the portion of the automatic gate arm that is farthest from the nearest rail.
 - B. If an automatic gate is not present on the approach, the upstream point is the portion of the stop line that is farthest from the nearest rail.
 - C. If the roadway is not paved, the upstream point is the point that is farthest from the nearest rail that is 10 feet measured perpendicular from the nearest rail.
- 02 The downstream point of the minimum track clearance distance is 6 feet beyond the track(s) or the edge of the downstream highway-highway intersection, whichever is closer, and is measured perpendicular to the farthest rail, along the center line or edge line of the highway, as appropriate, to obtain the longer distance. Where an Exit Gate system (see Section 8D.05) is present, the downstream point is the point where the rear of the vehicle would be clear of the exit gate arm. In cases where the exit gate arm is not perpendicular to the highway, the distance is measured either along the center line or edge line of the highway, as appropriate, to obtain the longer distance.
- 03 Where two adjacent grade crossings (see Section 8A.08) are located within 200 feet of each other as measured along the highway, the minimum track clearance distance is measured from a point that is upstream of the first grade crossing to a point that is downstream from the second grade crossing.
- 04 Where a highway-highway intersection is located beyond a grade crossing, the clear storage distance defines on a lane-by-lane basis the area of the roadway between the downstream point of the minimum track clearance distance and the intersection stop line, yield line, or normal stopping point on the highway.
- 05 The Highway-Rail Crossing Handbook contains an illustration of the minimum track clearance distance and the clear storage distance.
- 06 The minimum track clearance distance and the clear storage distance are used by the Diagnostic Team to determine the appropriate traffic control devices and/or roadway treatments to be used at the grade crossing, and to determine the queue start-up and queue clearance time necessary where a traffic signal or hybrid beacon is interconnected with a grade crossing active warning system.

Section 8A.08 Adjacent Grade Crossings*Support:*

- 01 Adjacent grade crossings sometimes exist within 200 feet of each other as measured along the highway between the inside rails. These closely-spaced grade crossings sometimes result from separate railroads or from a railroad and an LRT alignment operating in parallel corridors.

Guidance:

- 02 *Where adjacent grade crossings are located within 200 feet of each other along the highway as measured along the highway between the inside rails, the Diagnostic Team should consider the possibility that rail traffic might arrive at a grade crossing when rail traffic is already occupying the adjacent grade crossing.*

- 03 *Where the shortest distance between the tracks at adjacent grade crossings, measured along the highway between the inside rails, is 100 feet or less, the grade crossings should be treated as one individual grade crossing.*
- 04 *Where the shortest distance between the tracks at adjacent grade crossings, measured along the highway between the inside rails, is more than 100 feet and less than 200 feet, additional signs or other appropriate traffic control devices should be used to inform approaching road users of the long distance to cross the tracks.*
- 05 *Where active traffic control devices are installed between adjacent grade crossings that are more than 100 feet apart and less than 200 feet apart as measured along the highway between the inside rails, the operation of the devices should provide additional time for vehicles to clear the extended minimum track clearance distance (see Section 8A.07) that results from the closely-spaced grade crossings.*
- 06 *Where the shortest distance between the tracks at adjacent grade crossings, measured along the highway between the inside rails, is more than 200 feet, the grade crossings should be treated as individual grade crossings and traffic control devices should be installed between the grade crossings.*

Support:

- 07 The “2023 AREMA Communications and Signals Manual” published by the American Railway Engineering and Maintenance-of-Way Association (AREMA) contains further information and recommendations about the location and operation of active traffic control devices at adjacent grade crossings that are located within 200 feet of each other.

Section 8A.09 Grade Crossing Elimination

Option:

- 01 If a particular grade crossing appears to be redundant or unnecessary for motor vehicle, pedestrian, and bicycle traffic, an engineering study may be conducted to determine the costs and benefits of eliminating the crossing.

Guidance:

- 02 *If an engineering study is conducted, any necessary improvements to adjacent grade crossings and the surrounding roadway network to accommodate diverted traffic should also be included in the analysis.*
- 03 *If the conclusion of the engineering study is that the grade crossing should be eliminated, a Diagnostic Team should use the engineering study to determine the appropriate steps that need to be taken to accomplish the grade crossing elimination.*

Standard:

- 04 **Where a grade crossing is eliminated, the traffic control devices for the crossing shall be removed, and shall be covered or turned from view in the interim period prior to removal.**

Guidance:

- 05 *If the existing traffic control devices at a multiple-track grade crossing become improperly placed or are no longer applicable because of the removal of some of the tracks, the existing devices should be relocated and/or modified.*
- 06 *Where a roadway is removed from a grade crossing, the roadway approaches in the railroad or LRT right-of-way should also be removed and appropriate signs and object markers should be placed at the roadway end in accordance with Section 2C.73.*
- 07 *Where a railroad or LRT is eliminated at a grade crossing, the tracks should be removed or paved over.*

Option:

- 08 Based on engineering judgment, the TRACKS OUT OF SERVICE (R8-9) sign (see Figure 8B-1) may be temporarily installed until the tracks are removed or covered. The length of time before the tracks will be removed or covered may be considered in making the decision as to whether to install the sign.

Section 8A.10 Illumination at Grade Crossings

Support:

- 01 Illumination is sometimes installed at or adjacent to a grade crossing in order to provide better nighttime visibility of trains or LRT equipment and the grade crossing (for example, where a substantial amount of railroad or LRT operations are conducted at night, where grade crossings are blocked for extended periods of time, or where crash history indicates that road users experience difficulty in seeing trains or LRT equipment or traffic control devices during hours of darkness).

- 02 Recommended types and locations of luminaires for illuminating grade crossings are contained in the American National Standards Institute's "ANSI/IES RP-8-22, Recommended Practice: Lighting Roadway and Parking Facilities," which is available from the Illuminating Engineering Society.

Section 8A.11 Quiet Zone Treatments at Highway-Rail Grade Crossings

Support:

- 01 49 CFR Part 222 (Use of Locomotive Horns at Highway-Rail Grade Crossings; Final Rule) prescribes Quiet Zone requirements and treatments.

Standard:

- 02 **Any traffic control device and its application where used as part of a Quiet Zone shall comply with all applicable provisions of the TMUTCD. (See FHWA Known Errors 01/24/2025)**

Section 8A.12 Grade Crossings within or in Close Proximity to Circular Intersections

Support:

- 01 At circular intersections, such as roundabouts and traffic circles, that include or are within close proximity to a grade crossing, a queue of vehicular traffic could cause motor vehicles to stop on the grade crossing.

Standard:

- 02 **Where circular intersections include or are within 200 feet of a grade crossing, an engineering study shall be made to determine if queuing could impact the grade crossing.**

Guidance:

- 03 *The Diagnostic Team should review the findings of the engineering study and determine the appropriate measures to clear highway traffic from the grade crossing prior to the arrival of rail traffic.*

Support:

- 04 Among the actions that can be taken to keep the grade crossing clear of traffic or to clear traffic from the grade crossing prior to the arrival of rail traffic are the following:
- A. Grade crossing regulatory and warning devices;
 - B. Highway traffic signals;
 - C. Traffic metering devices;
 - D. Activated signs;
 - E. Geometric design revisions, including reconstruction or elimination of the circular intersection; or
 - F. A combination of these or other actions.

Section 8A.13 Temporary Traffic Control Zones

Support:

- 01 Temporary traffic control planning provides for continuity of operations (such as movement of motor vehicle traffic, pedestrians, and bicyclists, transit operations, and access to property/utilities) when the normal function of a roadway at a grade crossing is suspended because of temporary traffic control operations. Temporary traffic control planning is also needed when traffic is detoured over an existing grade crossing.

Standard:

- 02 **Traffic controls for temporary traffic control zones that include grade crossings shall be as provided in Part 6.**

Guidance:

- 03 *Where a temporary traffic control zone extends over an active grade crossing (see Section 6N.17), and where the direction of traffic in any lane is reversed over the grade crossing, the railroad company or transit agency should be part of the temporary traffic control planning process. Where a grade crossing warning system is not modified to support the temporary traffic control operation, at least one uniformed law enforcement officer should be in place at all times that rail traffic might approach or occupy the grade crossing.*
- 04 *Where traffic is detoured over an existing passive grade crossing, a temporary traffic control plan (see Section 6B.01) should be prepared.*
- 05 *Public and private agencies, emergency services, businesses, and railroad companies or transit agencies should meet to plan appropriate traffic detours and the necessary signing, marking, signalization, and flagging requirements for operations during temporary traffic control zone activities or during the period when traffic is being detoured over an existing passive grade crossing. Consideration should be given to the length of time that*

the grade crossing is to be closed, the length of time that a detour is to be in place, the type of rail or LRT and highway traffic affected, the time of day, and the materials and techniques of repair.

06 *The agencies responsible for the operation of the LRT and highway should be contacted when the initial planning begins for any temporary traffic control zone that might directly or indirectly influence the flow of traffic on facilities where LRT vehicles operate on a mixed-use alignment.*

07 *Temporary traffic control operations should minimize the inconvenience, delay, and crash potential to affected traffic. Prior notice should be given to affected public or private agencies, emergency services, businesses, railroad companies or transit agencies, and road users before the free movement of road users or rail traffic is infringed upon or blocked.*

Support:

08 Section 6N.17 contains additional information regarding temporary traffic control zones in the vicinity of grade crossings, and Figure 6P-46 shows an example of a typical situation that might be encountered.

CHAPTER 8B. SIGNS

Section 8B.01 Purpose and Application

Support:

- 01 Passive traffic control systems, consisting of signs and pavement markings only, identify and direct attention to the location of a grade crossing and advise road users to reduce their speed or stop at the grade crossing as necessary in order to yield to any rail traffic occupying, or approaching and in proximity to, the grade crossing.
- 02 Signs and markings regulate, warn, and guide the road users so that they, as well as LRT vehicle operators on mixed-use alignments, can take appropriate action when approaching a grade crossing.
- 03 Unless otherwise provided in this Chapter, the provisions of Part 2 are applicable to the design and location of signs at grade crossings.

Section 8B.02 Sizes of Grade Crossing Signs

Standard:

- 01 The minimum sizes of grade crossing signs shall be as shown in Table 8B-1.

Option:

- 02 Signs larger than those shown in Table 8B-1 may be used (see Section 2A.07).

Table 8B-1. Grade Crossing Sign and Plaque Minimum Sizes (Sheet 1 of 2)

Sign or Plaque	Sign Designation	Section	Conventional Road		Expressway	Minimum	Oversized
			Single Lane	Multi-Lane			
Stop	R1-1	8B.04, 8B.05	30 x 30	36 x 36	36 x 36	—	48 x 48
Yield	R1-2	8B.04, 8B.05	30 x 30 x 30	36 x 36 x 36	36 x 36 x 36	—	48 x 48 x 48
No Right Turn - Train (symbol)	R3-1a	8D.10	24 x 30	30 x 36	—	—	—
No Left Turn - Train (symbol)	R3-2a	8D.10	24 x 30	30 x 36	—	—	—
Do Not Stop on Tracks	R8-8	8B.07	24 x 30	24 x 30	36 x 48	—	36 x 48
Tracks Out of Service	R8-9	8B.08	24 x 24	24 x 24	36 x 36	—	36 x 36
Stop Here When Flashing	R8-10	8B.09	24 x 36	24 x 36	—	—	36 x 48
Stop Here When Flashing	R8-10a	8B.09	24 x 30	24 x 30	—	—	36 x 42
Stop Here on Red	R10-6	8B.10	24 x 36	24 x 36	—	—	36 x 48
Stop Here on Red	R10-6a	8B.10	24 x 30	24 x 30	—	—	36 x 42
Left (Right) Lane Signal	R10-10b	8D.11	30 x 36	30 x 36	—	24 x 30	—
Left (Right) Turn Lane Signal	R10-10c	8D.11	30 x 36	30 x 36	—	24 x 30	—
Grade Crossing (Crossbuck)	R15-1	8B.03	48 x 9	48 x 9	—	—	—
Number of Tracks (plaque)	R15-2P	8B.03	27 x 18	27 x 18	—	—	—
Exempt (plaque)	R15-3P	8B.11	24 x 12	24 x 12	—	—	—
Light Rail Only Right Lane	R15-4a	8B.12	24 x 30	24 x 30	—	—	—
Light Rail Only Left Lane	R15-4b	8B.12	24 x 30	24 x 30	—	—	—
Light Rail Only Center Lane	R15-4c	8B.12	24 x 30	24 x 30	—	—	—
Light Rail Do Not Pass (symbol)	R15-5	8B.13	24 x 30	24 x 30	—	—	—
Do Not Pass Stopped Train	R15-5a	8B.13	24 x 30	24 x 30	—	—	—
No Motor Vehicles On Tracks (symbol)	R15-6	8B.14	24 x 24	24 x 24	—	—	—

Notes: 1. Larger signs may be used when appropriate

2. Dimensions in inches are shown as width x height

3. Table 9A-1 shows the minimum sizes that may be used for grade crossing signs and plaques that face shared-use paths and pedestrian facilities

Table 8B–1. Grade Crossing Sign and Plaque Minimum Sizes (Sheet 2 of 2)

Sign or Plaque	Sign Designation	Section	Conventional Road		Expressway	Minimum	Oversized
			Single Lane	Multi-Lane			
Do Not Drive On Tracks	R15-6a	8B.14	24 x 30	24 x 30	—	—	—
Light Rail Divided Highway (symbol)	R15-7	8B.15	24 x 24	24 x 24	—	—	—
Light Rail Divided Highway (T-Intersection) (symbol)	R15-7a	8B.15	24 x 24	24 x 24	—	—	—
Look	R15-8	8E.03	—	—	—	18 x 9	—
Grade Crossing Advance Warning	W10-1	8B.06	36 Dia.	36 Dia.	48 Dia.	—	48 Dia.
Exempt (plaque)	W10-1aP	8B.11	24 x 12	24 x 12	—	—	—
Grade Crossing and Intersection Advance Warning (symbol)	W10-2,3,4	8B.06	36 x 36	36 x 36	48 x 48	—	48 x 48
Low Ground Clearance (symbol)	W10-5	8B.16	36 x 36	36 x 36	48 x 48	—	48 x 48
Low Ground Clearance (plaque)	W10-5P	8B.16	30 x 24	30 x 24	—	—	—
Uneven Tracks	W10-6T	8B.16A	30 x 30	36 x 36	—	—	—
Light Rail Activated Blank-Out (symbol)	W10-7	8B.17	24 x 24	24 x 24	—	—	—
Trains May Exceed 80 MPH	W10-8	8B.19	36 x 36	36 x 36	48 x 48	—	48 x 48
No Train Horn	W10-9	8B.20	36 x 36	36 x 36	48 x 48	—	48 x 48
No Train Horn (plaque)	W10-9P	8B.20	30 x 24	30 x 24	—	—	—
Storage Space (symbol)	W10-11	8B.21	36 x 36	36 x 36	48 x 48	—	48 x 48
Storage Space XX Feet between Tracks & Highway	W10-11a	8B.21	30 x 36	30 x 36	—	—	—
Storage Space XX Feet between Highway & Tracks Behind You	W10-11b	8B.21	30 x 36	30 x 36	—	—	—
Skewed Crossing (symbol)	W10-12	8B.22	36 x 36	36 x 36	48 x 48	—	48 x 48
No Gates or Lights (plaque)	W10-13P	8B.23	30 x 24	30 x 24	—	—	—
Next Crossing (plaque)	W10-14P	8B.24	30 x 24	30 x 24	—	—	—
Use Next Crossing (plaque)	W10-14aP	8B.24	30 x 24	30 x 24	—	—	—
Rough Crossing (plaque)	W10-15P	8B.25	30 x 24	30 x 24	—	—	36 x 30
Another Train Coming Activated Blank-Out	W10-16	8B.18	30 x 30	30 x 30	—	—	—
Busway Crossing	W10-21	8B.06	36x36	36x36	48x48	—	48x48
Signal Ahead (plaque)	W10-21aP	8B.06	30x24	30x24	—	—	—
Emergency Notification	I13-1	8B.27	—	—	—	12 x 9	—
Push to Exit	I13-2	8E.06	—	—	—	18 x 9	—

Notes: 1. Larger signs may be used when appropriate

2. Dimensions in inches are shown as width x height

3. Table 9A-1 shows the minimum sizes that may be used for grade crossing signs and plaques that face shared-use paths and pedestrian facilities

Section 8B.03 Grade Crossing (Crossbuck) Sign (R15-1) and Number of Tracks Plaque (R15-2P) at Active and Passive Grade Crossings

Standard:

- 01 **The Grade Crossing (R15-1) sign (see Figure 8B-1), commonly identified as the Crossbuck sign, shall be retroreflective white with the words RAILROAD CROSSING in black lettering, mounted as shown in Figure 8B-2.**

Support:

- 02 In **Texas**, the Crossbuck sign requires road users to yield the right-of-way to rail traffic at a grade crossing.

Standard:

- 03 **As a minimum, one Crossbuck sign shall be used on each highway approach to every highway-rail grade crossing, alone or in combination with other traffic control devices.**
- 04 **As a minimum, one Crossbuck sign shall be used on each highway approach to every highway-LRT grade crossing where flashing-light signals or automatic gates are used, alone or in combination with other traffic control devices.**

Option:

- 05 A Crossbuck sign may be used on a highway approach to a highway-LRT grade crossing where flashing-light signals or automatic gates are not used, alone or in combination with other traffic control devices.

Standard:

- 06 **If there are two or more tracks at a grade crossing, the number of tracks shall be indicated on a supplemental Number of Tracks (R15-2P) plaque (see Figure 8B-1) of inverted T shape mounted below the Crossbuck sign in the manner shown in Figure 8B-2.**
- 07 **On each approach to a highway-rail grade crossing and, if used, on each approach to a highway-LRT grade crossing, the Crossbuck sign shall be installed on the right-hand side of the highway on each approach to the grade crossing. Where restricted sight distance or unfavorable highway geometry exists on an approach to a grade crossing, or where there is a one-way multi-lane approach, an additional Crossbuck sign shall be installed on the left-hand side of the highway, possibly placed back-to-back with the Crossbuck sign for the opposite approach, or otherwise located so that two Crossbuck signs are displayed for that approach.**
- 08 **A strip of retroreflective white material not less than 2 inches in width shall be used on the back of each blade of each Crossbuck sign for the length of each blade at all passive grade crossings, except those where Crossbuck signs have been installed back-to-back or where double-faced Crossbuck signs have been installed.**

Option:

- 09 A strip of retroreflective white material not less than 2 inches in width may be used on the back of each blade of each Crossbuck sign for the length of each blade at active grade crossings.

Guidance:

- 10 *Minimum clearance dimensions for crossbuck signs relative to the proximity to the nearest rail should conform to the requirements of the railroad company and/or transit agency, and the regulatory agency with statutory authority (if applicable).*
- 11 *Except as provided in Paragraph 12 of this Section, the mounting height of Crossbuck signs, measured vertically from the center of the sign to the elevation of the near edge of the pavement, should be approximately 9 feet (see Figure 8B-2).*

Option:

- 12 The 9-foot mounting height for the Crossbuck sign may be varied as required by local conditions and may be increased to accommodate signs mounted below the Crossbuck sign.

Figure 8B-1. Regulatory Signs and Plaques for Grade Crossings



R1-1



R1-2



R3-1a
Activated Blank-Out



R3-2a
Activated Blank-Out



R8-8



R8-9



R8-10



R8-10a



R10-6



R10-6a



R10-10b

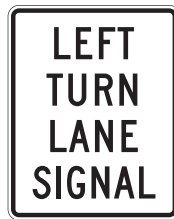

R10-10c



R15-1



R15-2P



R15-3P



R15-4a



R15-4b



R15-4c



R15-5



R15-5a



R15-6



R15-6a



R15-7



R15-7a



R15-8

Figure 8B-2. Crossbuck Assembly with a YIELD or STOP Sign on the Crossbuck Sign Support

- * Height may be varied as required by local conditions and may be increased to accommodate signs mounted below the Crossbuck sign
- ** Measured to the elevation of the near edge of the roadway

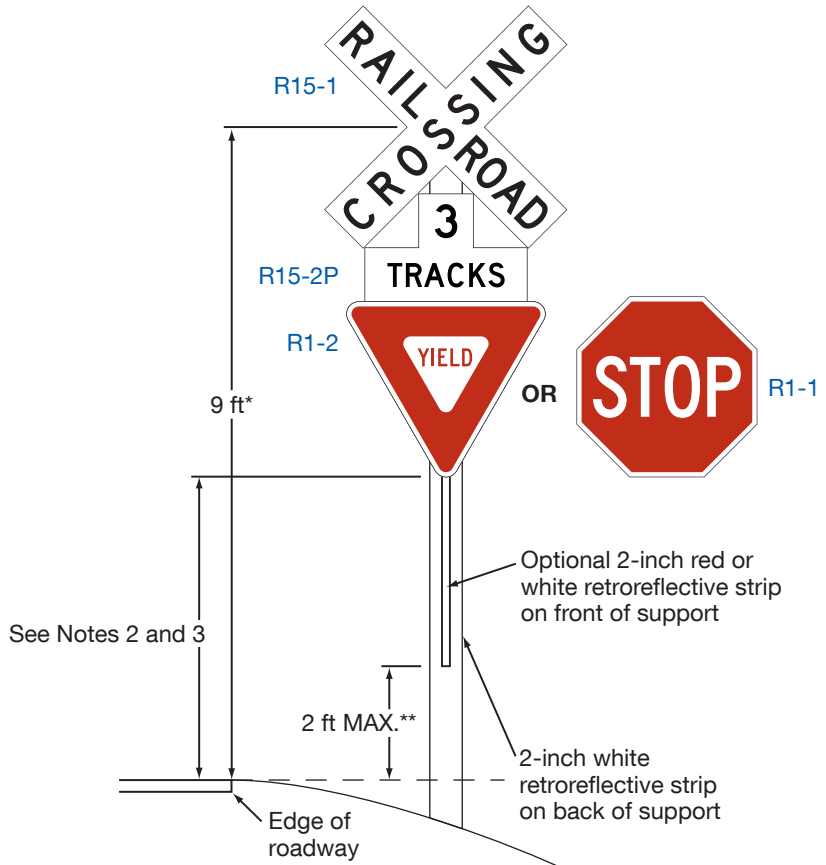

Notes:

1. YIELD or STOP signs are used only at passive crossings. A STOP sign is used only if an engineering study determines that it is appropriate for that particular approach.
2. Mounting height shall be at least 5 feet for installations of YIELD or STOP signs on existing Crossbuck sign supports, where prevailing speed of vehicle traffic is 40mph or less.
3. Mounting height shall be at least 7 feet for new installations in rural areas and at least 7 feet for new installations and for any installations where the prevailing speed of vehicle traffic exceeds 40 mph.

Section 8B.04 Crossbuck Assemblies with YIELD or STOP Signs at Passive Grade Crossings

Standard:

- 01 **A Crossbuck Assembly shall consist of a Crossbuck (R15-1) sign, and a Number of Tracks (R15-2P) plaque if two or more tracks are present, that complies with the provisions of Section 8B.03, and either a YIELD (R1-2) or STOP (R1-1) sign installed on the same support, except as provided in Paragraph 10 of this Section. YIELD or STOP signs used at passive grade crossings shall be installed in compliance with the provisions of Section 2B.18, and Figures 8B-2 and 8B-3.**
- 02 **At all public highway-rail grade crossings that are not equipped with the active traffic control systems that are described in Chapter 8D, except crossings where road users are directed by an authorized person on the ground to not enter the crossing at all times that an approaching train is about to occupy the crossing, a Crossbuck Assembly shall be installed on the right-hand side of the highway on each approach to the highway-rail grade crossing.**
- 03 **If a Crossbuck sign is used on a highway approach to a public highway-LRT grade crossing that is not equipped with the active traffic control systems that are described in Chapter 8D, a Crossbuck Assembly shall be installed on the right-hand side of the highway on each approach to the highway-LRT grade crossing.**
- 04 **Where restricted sight distance or unfavorable highway geometry exists on an approach to a grade crossing that has a Crossbuck Assembly, or where there is a one-way multi-lane approach, an additional Crossbuck Assembly shall be installed on the left-hand side of the highway.**
- 05 **A YIELD sign shall be the default traffic control device for Crossbuck Assemblies on all highway approaches to passive grade crossings unless an engineering study performed by the regulatory agency or highway authority having jurisdiction over the roadway approach determines that a STOP sign is appropriate.**

Guidance:

- 06 *The use of STOP signs at passive grade crossings should be limited to unusual conditions where requiring all motor vehicles to make a full stop is determined to be necessary by a Diagnostic Team. Among the factors that should be considered by the Diagnostic Team are the line of sight to approaching rail traffic (giving due consideration to seasonal crops or vegetation beyond both the highway and railroad or LRT rights-of-ways), the number of tracks, the speeds of trains or LRT equipment and motor vehicles, and the crash history at the grade crossing.*
- 07 *Where a passive grade crossing is located on a stop-controlled approach and the clear storage distance is less than the length of the design vehicle, and where adequate sight distance to oncoming traffic on the parallel roadway is available to road users stopped on the approach to the grade crossing, consideration should be given to installing a STOP sign at the Crossbuck Assembly instead of at the highway-highway intersection. If the STOP sign is installed at the Crossbuck Assembly instead of at the highway-highway intersection, the Diagnostic Team should consider installing some other intersection traffic control device at the highway-highway intersection.*

Standard:

- 08 **If a Crossbuck Assembly is installed on the approach to a passive grade crossing located at a highway-highway intersection controlled by a traffic control signal that is not interconnected with the grade crossing and not preempted by the approach of rail traffic, a Diagnostic Team shall be convened to determine the appropriate traffic control devices. A STOP sign shall not be installed on a Crossbuck Assembly in this situation.**

Support:

- 09 Sections 8A.01 through 8A.05 contain information regarding the responsibilities of the Diagnostic Team, highway agency, regulatory agency with statutory authority (if applicable), and the railroad company or transit agency regarding the selection, design, and operation of traffic control devices placed at grade crossings.

Option:

- 10 **If a YIELD or STOP sign is installed for a Crossbuck Assembly at a grade crossing, it may be installed on the same support as the Crossbuck sign or it may be installed on a separate support at a point where the motor vehicle is to stop, or as near to that point as practicable, but in either case, the YIELD or STOP sign is considered to be a part of the Crossbuck Assembly.**

Standard:

- 11 If a YIELD or STOP sign is installed on an existing Crossbuck sign support, the mounting height, measured vertically from the bottom of the YIELD or STOP sign to the top of the curb, or in the absence of curb, measured vertically from the bottom of the YIELD or STOP sign to the elevation of the near edge of the traveled way, shall be at least 7 feet (see Figure 8B-2).

Option:

- 12 The minimum mounting height specified in Paragraph 11 of this section may be reduced to 5 feet on roadways where prevailing vehicle speeds are 40 mph or less.

Standard:

- 13 If a Crossbuck Assembly is installed on a new sign support (see Figure 8B-2) or if the YIELD or STOP sign is installed on a separate support (see Figure 8B-3), the mounting height, measured vertically from the bottom of the YIELD or STOP sign to the top of the curb, or in the absence of curb, measured vertically from the bottom of the YIELD or STOP sign to the elevation of the near edge of the traveled way, shall be at least 7 feet.

Guidance:

- 14 If a YIELD or STOP sign is installed for a Crossbuck Assembly at a grade crossing on a separate support than the Crossbuck sign (see Figure 8B-3), the YIELD or STOP sign should be placed in the same plane as the Crossbuck sign and closer to the traveled way than the Crossbuck sign. The minimum separation between the nearest point of the YIELD or STOP sign and the nearest point of the Crossbuck sign should be 2 inches as shown in Figure 8B-3.

Support:

- 15 The meaning of a Crossbuck Assembly that includes a YIELD sign is that a road user approaching the grade crossing needs to be prepared to decelerate, and when necessary, yield the right-of-way to any rail traffic that might be occupying the crossing or might be approaching and in such close proximity to the crossing that it would be unsafe for the road user to cross.
- 16 Certain commercial motor vehicles and school buses are required to stop at all grade crossings in accordance with 49 CFR 392.10 even if a YIELD sign (or just a Crossbuck sign) is posted.
- 17 The meaning of a Crossbuck Assembly that includes a STOP sign is that a road user approaching the grade crossing must come to a full stop not less than 15 feet short of the nearest rail, and remain stopped while the road user determines if there is rail traffic either occupying the crossing or approaching and in such close proximity to the crossing that the road user must yield the right-of-way to rail traffic. The road user is permitted to proceed when it is safe to cross.

Standard:

- 18 A vertical strip of retroreflective white material, not less than 2 inches in width, shall be used on each Crossbuck support at passive grade crossings for the full length of the back of the support from the Crossbuck sign or Number of Tracks plaque to within 2 feet above the near edge of the roadway, except as provided in Paragraph 19 of this Section. A white retroreflective strip wrapped around a round support for the full length of the support from the Crossbuck Sign or Number of Tracks plaque to within 2 feet above the near edge of the roadway shall satisfy this requirement as long as the round support has an outside diameter of at least 2 inches.

Option:

- 19 The vertical strip of retroreflective material may be omitted from the back sides of Crossbuck sign supports installed on one-way streets and at pathway or sidewalk grade crossings (see Section 8E.05).
- 20 If a YIELD or STOP sign is installed on the same support as the Crossbuck sign, a vertical strip of red (see Section 2A.11) or white retroreflective material that is at least 2 inches wide may be used on the front of the support from the YIELD or STOP sign to within 2 feet above the near edge of the roadway.

Standard:

- 21 If a Crossbuck sign support at a passive grade crossing does not include a YIELD or STOP sign (either because the YIELD or STOP sign is placed on a separate support or because a YIELD or STOP sign is not present on the approach), a vertical strip of retroreflective white material, not less than 2 inches in width, shall be used for the full length of the front of the support from the Crossbuck sign or Number of Tracks plaque to within 2 feet above the near edge of the roadway. A white retroreflective strip wrapped around a round support for the full length of the support from the Crossbuck Sign or Number of Tracks

plaque to within 2 feet above the near edge of the roadway shall satisfy this requirement as long as the round support has an outside diameter of at least 2 inches.

22 At all grade crossings where YIELD or STOP signs are installed, Yield Ahead (W3-2) or Stop Ahead (W3-1) signs shall also be installed if the criteria for their installation in Section 2C.35 is met.

Support:

23 Section 8C.03 contains provisions regarding the use of stop lines at grade crossings.

Figure 8B-3. Crossbuck Assembly with a YIELD or STOP Sign on a Separate Sign Support

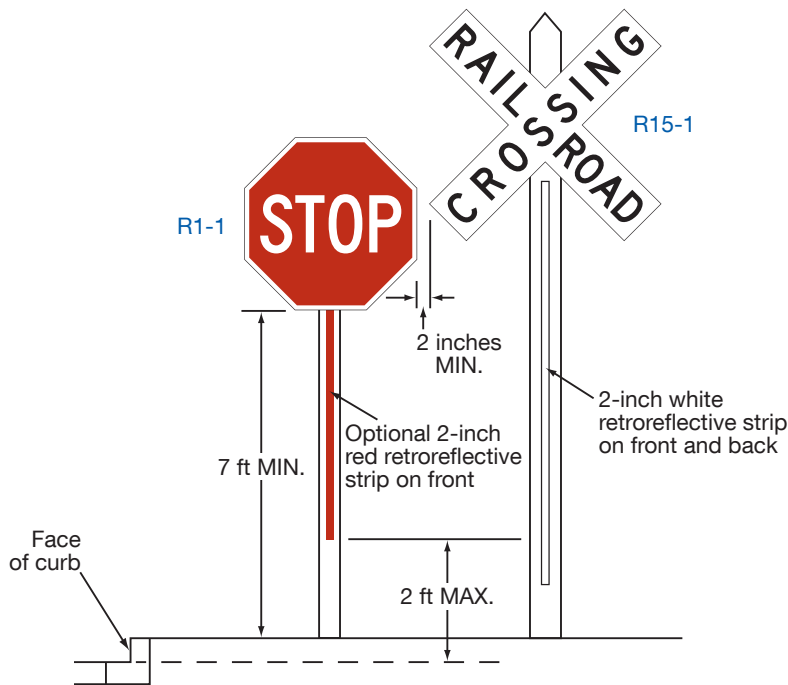
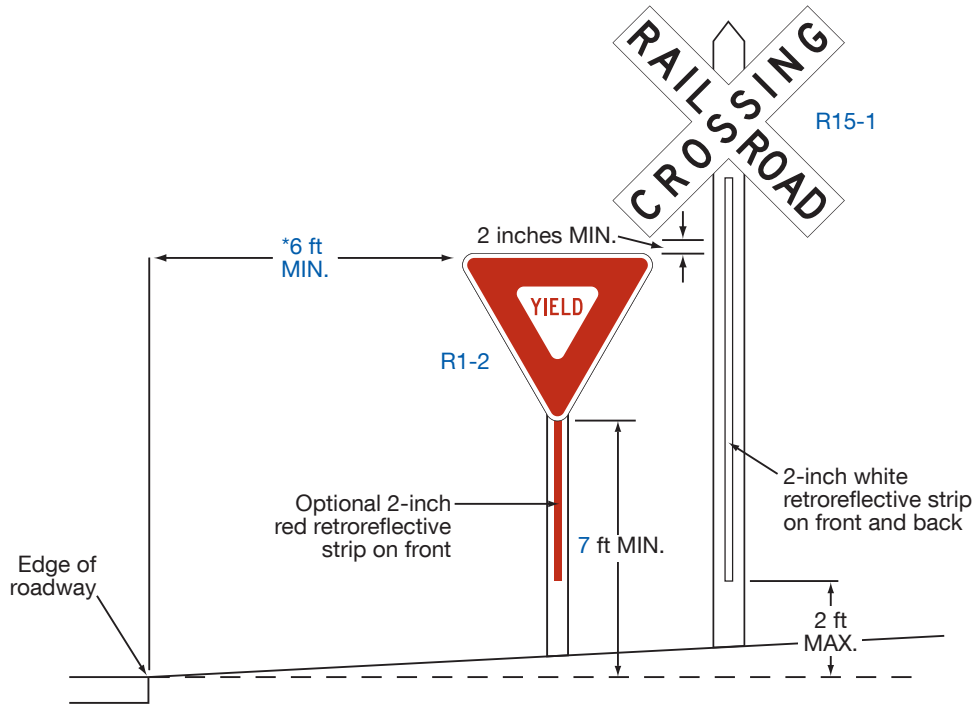

AREA WITH PEDESTRIAN MOVEMENTS OR PARKING

Notes:

1. YIELD or STOP signs are used only at passive crossings. A STOP sign is used only if an engineering study determines that it is appropriate for that particular approach.
2. Place the face of the signs in the same plane and place the YIELD or STOP sign closest to the traveled way. Provide a 2-inch minimum separation between the edge of the Crossbuck sign and the edge of the YIELD or STOP sign.
- * If curb exists, off set should be 2 feet minimum from face of curb.

Figure 8B-3. ~~Crossbuck Assembly with a YIELD or STOP Sign on a Separate Sign Support (Sheet 2 of 2)~~ DELETED

Section 8B.05 Use of STOP (R1-1) or YIELD (R1-2) Signs without Crossbuck Signs at Highway-LRT Grade Crossings

Guidance:

- 01 *The use of only STOP or YIELD signs for road users at highway-LRT grade crossings should be limited to those crossings where the need and feasibility is determined by the Diagnostic Team. Such crossings should have all of the following characteristics:*
- A. *The crossing roadways are secondary in character (such as a minor street with one lane in each direction, an alley, or a driveway) with low traffic volumes and low speed limits. The specific thresholds of traffic volumes and speed limits should be determined by the local agencies.*
 - B. *The line of sight for an approaching LRT operator is adequate from a sufficient distance such that the operator can sound an audible signal and bring the LRT equipment to a stop before arriving at the crossing.*
 - C. *The road user has sufficient sight distance at the stop line to permit the vehicle to cross the tracks before the arrival of the LRT equipment.*
 - D. *If at an intersection of two roadways, the intersection does not meet the warrants for a traffic control signal as provided in Chapter 4C.*
 - E. *The LRT tracks are located such that motor vehicles are not likely to stop on the tracks while waiting to enter a crossroad or highway.*

Standard:

- 02 **For all highway-LRT grade crossings where only STOP (R1-1) or YIELD (R1-2) signs are installed, the placement shall comply with the requirements of Section 2B.18. Stop Ahead (W3-1) or Yield Ahead (W3-2) Advance Warning signs shall also be installed if the criteria for their installation given in Section 2C.35 is met.**

Section 8B.06 Grade Crossing Advance Warning Signs (W10-1 through W10-4)

Standard:

- 01 **A Grade Crossing Advance Warning (W10-1) sign (see Figure 8B-4) shall be used on each highway in advance of every grade crossing, except in the following circumstances:**
- A. **On an approach to a grade crossing from an intersection with a parallel highway if the distance from the nearest rail of the tracks to the edge of the parallel roadway is less than 100 feet and W10-2, W10-3, or W10-4 signs are used on the approaches of the parallel highway (see Paragraph 5 of this Section);**
 - B. **On low-volume, low-speed highways crossing minor spurs or other tracks that are infrequently used and road users are directed by an authorized person on the ground to not enter the crossing at all times that approaching rail traffic is about to occupy the crossing;**
 - C. **In business or commercial areas where active grade crossing traffic control systems are in use;**
 - D. **Where physical conditions do not permit even a partially effective display of the sign; or**
 - E. **At highway-LRT grade crossings where Crossbuck signs are not used (see Section 8B.03).**
- 02 **The placement of the Grade Crossing Advance Warning sign shall be in accordance with Section 2C.04 and Table 2C-3.**
- 03 **If a YIELD or STOP sign is present at a passive grade crossing, a Yield Ahead (W3-2) or Stop Ahead (W3-1) Advance Warning sign shall also be installed if the criteria for their installation given in Section 2C.35 is met. If a Yield Ahead or Stop Ahead sign is installed on the approach to the crossing, the W10-1 sign shall be installed upstream from the Yield Ahead or Stop Ahead sign. The Yield Ahead or Stop Ahead sign shall be located in accordance with Table 2C-3. The minimum distance between the signs shall be in accordance with Section 2C.04 and Table 2C-3.**

Option:

- 04 **On divided highways and one-way streets, an additional W10-1 sign may be installed on the left-hand side of the roadway.**

Standard:

- 05 If the distance between the tracks and a parallel highway, from the nearest rail of the tracks to the edge of the parallel roadway, is less than 100 feet, a W10-2, W10-3, or W10-4 sign (see Figure 8B-4) shall be installed on each approach of the parallel highway to warn road users making a turn that they will encounter a grade crossing soon after making a turn, and a W10-1 sign for the approach to the tracks shall not be required to be between the tracks and the parallel highway.
- 06 If the W10-2, W10-3, or W10-4 sign is used, sign placement in accordance with the guidelines for Intersection Warning signs in Table 2C-3 using the speed of through traffic shall be measured from the highway intersection.

Guidance:

- 07 If the distance between the tracks and the parallel highway, from the nearest rail of the tracks to the edge of the parallel roadway, is 100 feet or more, a W10-1 sign should be installed in advance of the grade crossing, and the W10-2, W10-3, or W10-4 sign should not be used on the parallel highway.

Figure 8B-4. Warning Signs and Plaques for Grade Crossing

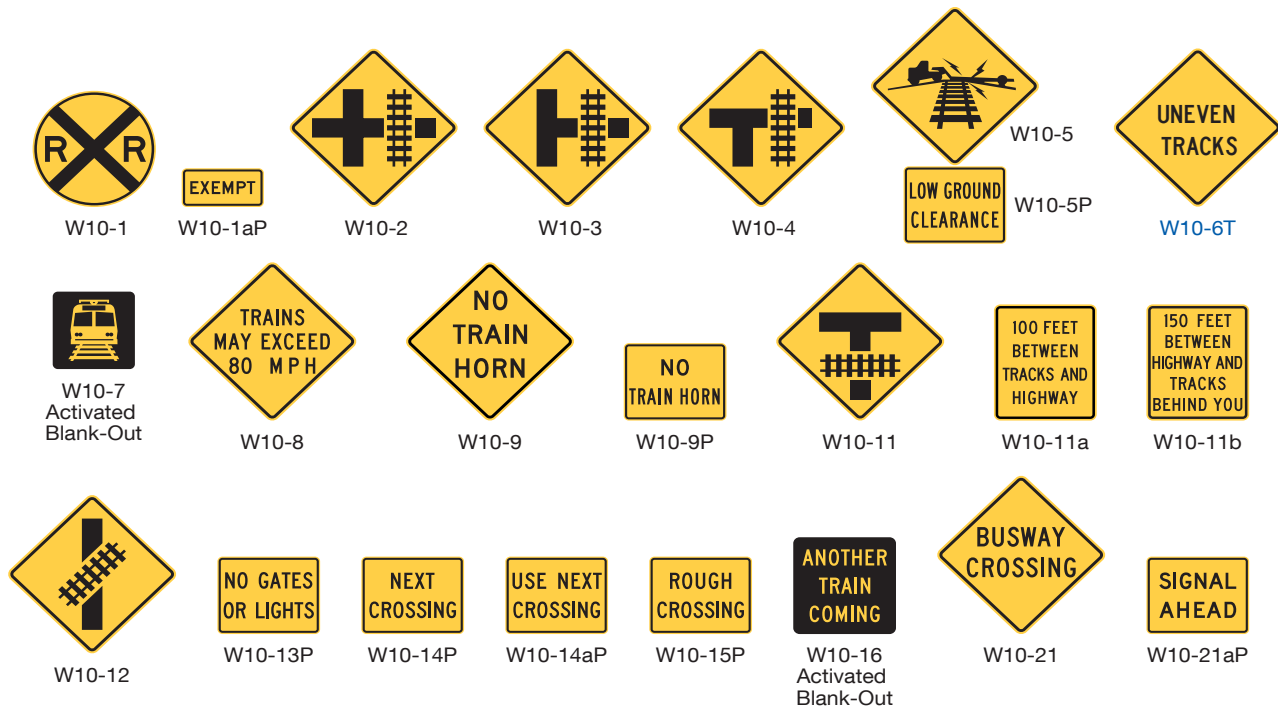

Note: The W10-11 sign is a W10-3 sign modified for geometrics. Other signs can be oriented or revised as needed to better portray the geometrics of the roadways and the tracks.

Section 8B.07 DO NOT STOP ON TRACKS Sign (R8-8)

Guidance:

- 01 If motor vehicle queues are likely to extend onto the tracks, a DO NOT STOP ON TRACKS (R8-8) sign (see Figure 8B-1) should be used.

Support:

- 02 Locations where motor vehicles could queue onto the grade crossing include intersections where a STOP or YIELD sign is installed downstream of the grade crossing, where there is a downstream circular intersection, or where there is a pre-signal installed at the grade crossing.

Guidance:

- 03 The R8-8 sign, if used, should be located on the right-hand side of the highway on either the near or far side of the grade crossing, depending upon which position provides better visibility to approaching drivers.

Option:

- 04 DO NOT STOP ON TRACKS signs may be placed on both sides of the track.
- 05 On divided highways and one-way streets, a second DO NOT STOP ON TRACKS sign may be placed on the near or far left-hand side of the highway at the grade crossing to further improve the visibility of the sign.

Section 8B.08 TRACKS OUT OF SERVICE Sign (R8-9)

Option:

- 01 The TRACKS OUT OF SERVICE (R8-9) sign (see Figure 8B-1) may be used at a grade crossing instead of a Crossbuck (R15-1) sign and a Number of Tracks (R15-2P) plaque or instead of a Crossbuck Assembly where railroad or LRT tracks have been temporarily or permanently abandoned, but only until such time that the tracks are removed or covered.

Standard:

- 02 **Where tracks are out of service, except as provided in Paragraphs 3 and 4 of this Section, traffic control devices and gate arms shall be removed and the signal heads shall be removed or hooded or turned from view to clearly indicate that they are not in operation.**
- 03 **Where tracks are out of service, even if a TRACKS OUT OF SERVICE (R8-9) sign has been installed, an Emergency Notification System (I13-1) sign (see Section 8B.27) shall be retained at the grade crossing and shall be visible to road users.**

Guidance:

- 04 *Warning signs, such as the Low Ground Clearance Grade Crossing (W10-5) sign and the Skewed Crossing (W10-12) sign, that warn road users about physical roadway conditions at the grade crossing should be left in place after the tracks are taken out of service, until the physical condition is no longer present. (See FHWA Known Errors 01/24/2025)*

Standard:

- 05 **The R8-9 sign shall be removed when the tracks have been removed or paved over or when the grade crossing is returned to service. The Emergency Notification System (I13-1) sign shall be removed when the tracks have been removed or paved over.**

Section 8B.09 STOP HERE WHEN FLASHING Signs (R8-10 and R8-10a)

Option:

- 01 The STOP HERE WHEN FLASHING (R8-10 and R8-10a) signs (see Figure 8B-1) may be used at a grade crossing to inform drivers of the location of the stop line or the point at which to stop when the flashing-light signals (see Section 8D.02) are activated.

Section 8B.10 STOP HERE ON RED Signs (R10-6 and R10-6a)

Support:

- 01 The STOP HERE ON RED (R10-6 or R10-6a) sign (see Figure 8B-1) defines and facilitates observance of stop lines at traffic control signals.

Option:

- 02 STOP HERE ON RED signs may be used at locations where motor vehicles frequently violate the stop line or where it is not obvious to road users where to stop.

Guidance:

- 03 *If possible, stop lines should be placed at a point where the motor vehicle driver has adequate sight distance along the track.*

Section 8B.11 EXEMPT Grade Crossing Plaques (R15-3P and W10-1aP)

Option:

- 01 Where authorized by law or regulation, an EXEMPT (R15-3P) plaque (see Figure 8B-1) with a white background may be used below the Crossbuck sign or Number of Tracks plaque, if present, at the grade crossing, and an EXEMPT (W10-1aP) plaque (see Figure 8B-4) with a yellow background may be used below the Grade Crossing Advance Warning (W10-1 through W10-4) sign.
- 02 Where neither the Crossbuck sign nor the advance warning signs exist for a particular highway-LRT grade crossing, an EXEMPT (R15-3P) plaque with a white background may be placed on its own post on the near right-hand side of the approach to the crossing.

Support:

- 03 These plaques inform drivers of motor vehicles carrying passengers for hire, school buses carrying students, or motor vehicles carrying hazardous materials that a stop is not required at certain designated grade crossings, except when rail traffic is approaching or occupying the grade crossing, or the driver's view is blocked.

Section 8B.12 Light Rail Transit Only Lane Signs (R15-4 Series)**Support:**

- 01 The Light Rail Transit Only Lane (R15-4 series) signs (see Figure 8B-1) are used for multi-lane operations, where road users might need additional guidance on lane use and/or restrictions.

Option:

- 02 Light Rail Transit Only Lane signs may be used on a roadway lane limited to only LRT use to indicate the restricted use of a lane in semi-exclusive and mixed alignments.

Guidance:

- 03 *If used, the R15-4a, R15-4b, and R15-4c signs should be installed on posts adjacent to the roadway containing the LRT tracks or overhead above the LRT only lane.*

Option:

- 04 If the trackway is paved, preferential lane markings (see Chapter 3E) may be installed, but only in combination with Light Rail Transit Only Lane signs.

Support:

- 05 The trackway is the continuous way designated for LRT, including the entire dynamic envelope. Section 8C.06 contains more information regarding the dynamic envelope.

Section 8B.13 Do Not Pass Light Rail Transit Signs (R15-5 and R15-5a)**Support:**

- 01 A Do Not Pass Light Rail Transit (R15-5) sign (see Figure 8B-1) is used to indicate that motor vehicles are not allowed to pass LRT vehicles that are loading or unloading passengers where there is no raised platform or physical separation from the lanes upon which other motor vehicles are operating.

Option:

- 02 The R15-5 sign may be used in mixed-use alignments and may be mounted overhead where there are multiple lanes.
- 03 Instead of the R15-5 symbol sign, a regulatory sign with the word message DO NOT PASS STOPPED TRAIN (R15-5a) may be used (see Figure 8B-1).

Guidance:

- 04 *If used, the R15-5 or R15-5a sign should be located immediately before the LRT boarding area.*

Section 8B.14 No Motor Vehicles on Tracks Signs (R15-6 and R15-6a)**Support:**

- 01 The No Motor Vehicles On Tracks (R15-6) sign (see Figure 8B-1) is used where there are adjacent traffic lanes separated from the LRT lane by a curb or pavement markings.

Guidance:

- 02 *The DO NOT ENTER (R5-1) sign should be used where a road user could wrongly enter an LRT only street.*

Option:

- 03 A No Motor Vehicles On Tracks sign may be used to deter motor vehicles from driving on the trackway. It may be installed on a 3-foot flexible post between double tracks, on a post alongside the tracks, or overhead.
- 04 Instead of the R15-6 symbol sign, a regulatory sign with the word message DO NOT DRIVE ON TRACKS (R15-6a) may be used (see Figure 8B-1).
- 05 A reduced size of 12 x 12 inches may be used if the R15-6 sign is installed between double tracks.

Standard:

- 06 **The smallest size for the R15-6 sign shall be 12 x 12 inches.**

Section 8B.15 Divided Highway with Light Rail Transit Crossing Signs (R15-7 Series)

Option:

- 01 The Divided Highway with Light Rail Transit Crossing (R15-7 or R15-7a) sign (see Figure 8B-1) may be used as a supplemental sign on the approach legs of a roadway that intersects with a divided highway where LRT equipment operates in the median. The sign may be placed beneath a STOP sign or mounted separately.

Guidance:

- 02 *The number of tracks displayed on the R15-7 or R15-7a sign should be the same as the actual number of tracks.*

Standard:

- 03 **When the Divided Highway with Light Rail Transit Crossing sign is used at a four-leg intersection, the R15-7 sign shall be used. When used at a T-intersection, the R15-7a sign shall be used.**

Section 8B.16 Low Ground Clearance Grade Crossing Sign (W10-5)

Guidance:

- 01 *If the highway profile conditions are sufficiently abrupt to create a hang-up situation for long wheelbase vehicles or for trailers with low ground clearance, the Low Ground Clearance Grade Crossing (W10-5) sign (see Figure 8B-4) should be installed in advance of the grade crossing.*

Standard:

- 02 **Because this symbol might not be readily recognizable by the public, the Low Ground Clearance Grade Crossing (W10-5) warning sign shall be accompanied by a LOW GROUND CLEARANCE (W10-5P) educational plaque. The LOW GROUND CLEARANCE educational plaque shall remain in place for at least 3 years after the initial installation of the W10-5 sign (see Section 2A.09).**

Guidance:

- 03 *Because other vehicle types and combinations also face the potential risk of hanging up at a grade crossing, word message warning signs and selective exclusion regulatory signs (see Section 2B.45) for specific vehicle types and combinations should be used in addition to, or in place of, the Low Ground Clearance Grade Crossing (W10-5) sign.*

Support:

- 04 While not all inclusive, some potential low ground clearance vehicles and combinations include single-unit trucks, buses, motor coaches, low-boy trailers, car carriers, and recreational vehicles.

Guidance:

- 05 *Auxiliary plaques such as AHEAD, NEXT CROSSING, or USE NEXT CROSSING (with appropriate arrows), or a supplemental distance plaque should be placed below the W10-5 sign at the nearest intersecting highway where a vehicle can detour or at a point on the highway wide enough to permit a U-turn.*
- 06 *If engineering judgment of roadway geometric and operating conditions confirms that motor vehicle speeds across the tracks should be below the posted speed limit, a W13-1P advisory speed plaque should be posted.*
- 07 *A signed detour should be installed to guide potential hang-up vehicles to alternate nearby crossings to avoid the potential hang-up condition.*

Support:

- 08 Information on ground clearance requirements at grade crossings is available in the 2019 edition of the “American Railway Engineering and Maintenance-of-Way Association’s Engineering Manual,” or in “A Policy on Geometric Design of Highways and Streets,” 2018 Edition, AASHTO.
- 09 An inventory of crossings with low ground clearance concerns, including a list of potential vehicle types that could hang up on the crossing, can be useful in tracking locations of low ground clearance crossings. Specific geometric conditions, known incidents, or anecdotal evidence of vehicle hang-ups can also be used to identify crossings with low ground clearance concerns.

Section 8B.16A UNEVEN TRACKS Sign (W10-6T)

Support:

- 01 The UNEVEN TRACKS (W10-6T) sign (see Figure 8B-4) warns of a railroad crossing that is so uneven or rough as to be hazardous to vehicles crossing the tracks at the normal speed on the approach roadway.

Option:

- 02 Additional warning may be provided by use of the ADVISORY SPEED (W13-1P) plaque.

Guidance:

- 03 *When used, the UNEVEN TRACKS sign should be installed 100 feet beyond the GRADE CROSSING ADVANCE WARNING (W10-1) sign, subject to adjustment for local conditions.*

Section 8B.17 Light Rail Transit Approaching-Activated Blank-Out Warning Sign (W10-7)

Support:

- 01 The Light Rail Transit Approaching-Activated Blank-Out (W10-7) warning sign (see Figure 8B-4) supplements the traffic control devices to warn road users crossing the tracks of approaching LRT equipment.

Option:

- 02 A Light Rail Transit Approaching-Activated Blank-Out warning sign may be used at signalized intersections near highway-LRT grade crossings or at crossings controlled by STOP signs or automatic gates.

Support:

- 03 The provisions contained in Chapter 2L for blank-out signs are applicable to the W10-7 sign.

Section 8B.18 Another Train Coming Sign (W10-16)

Support:

- 01 Conflicts between vehicles or vulnerable road users and multiple trains can occur at multi-track crossings on sidewalks, pathways, and at crossings in station areas where grade crossing users might not consider the arrival of another train on a different track.

Guidance:

- 02 *The decision to provide notification of another train should be made by a Diagnostic Team. In making this determination, the Diagnostic Team should consider the pedestrian usage, pedestrian collision history, train speeds and volumes, operating plans and/or schedules, and the presence of a nearby station or transit center.*

Option:

- 03 An ANOTHER TRAIN COMING (W10-16) train-activated blank-out sign (see Figure 8B-4) may be used to provide notification of another train coming. For added sign conspicuity, a Warning Beacon may be used in accordance with the requirements of Section 4S.03.

Section 8B.19 TRAINS MAY EXCEED 80 MPH Sign (W10-8)*Guidance:*

- 01 *Where trains are permitted to travel at speeds exceeding 80 mph, a TRAINS MAY EXCEED 80 MPH (W10-8) sign (see Figure 8B-4) should be installed facing road users approaching the highway-rail grade crossing.*
- 02 *If used, the TRAINS MAY EXCEED 80 MPH signs should be installed between the Grade Crossing Advance Warning (W10-1 through W10-4) sign (see Figure 8B-4) and the highway-rail grade crossing on all approaches to the highway-rail grade crossing. The locations should be determined based on specific site conditions.*

Section 8B.20 NO TRAIN HORN Sign or Plaque (W10-9 and W10-9P)**Standard:**

- 01 **Either a NO TRAIN HORN (W10-9) sign (see Figure 8B-4) or a NO TRAIN HORN (W10-9P) plaque (see Figure 8B-4) shall be installed in each direction at each highway-rail grade crossing where a Quiet Zone has been established in compliance with 49 CFR Part 222. If a W10-9P plaque is used, it shall supplement and be mounted directly below the Grade Crossing Advance Warning (W10-1 through W10-4) sign (see Figure 8B-4).**

Section 8B.21 Storage Space Signs (W10-11, W10-11a, and W10-11b)*Guidance:*

- 01 *A Storage Space (W10-11) sign supplemented by a word message Storage Space Ahead (W10-11a) sign (see Figure 8B-4) should be used where there is a highway intersection in close proximity to the grade crossing and the Diagnostic Team determines that adequate space is not available to store a design vehicle(s) between the highway intersection and the train or LRT equipment dynamic envelope.*
- 02 *The Storage Space (W10-11 and W10-11a) signs should be mounted in advance of the grade crossing at an appropriate location to advise drivers of the space available for motor vehicle storage between the highway intersection and the grade crossing.*

Option:

- 03 A word message Storage Space Behind (W10-11b) sign (see Figure 8B-4) may be mounted beyond the grade crossing at the highway intersection under the STOP or YIELD sign or just prior to the signalized intersection to remind drivers of the storage space between the tracks and the highway intersection.

Standard:

- 04 **A Storage Space (W10-11) sign shall not be used as a replacement for the required Advance Warning (W10-1) sign. If used, the Storage Space sign shall be used in addition to the W10-1 sign and shall be mounted on a separate post.**

Section 8B.22 Skewed Crossing Sign (W10-12)

Option:

- 01 The Skewed Crossing (W10-12) sign (see Figure 8B-4) may be used at a skewed grade crossing to warn road users that the tracks are not perpendicular to the highway.

Guidance:

- 02 *If the Skewed Crossing sign is used, the symbol should show the direction of the crossing (near left to far right as shown on the sign image in Figure 8B-4, or the mirror image if the track goes from far left to near right).*

Standard:

- 03 **The Skewed Crossing sign shall not be used as a replacement for the required Advance Warning (W10-1) sign. If used, the Skewed Crossing sign shall be used in addition to the W10-1 sign and shall be mounted on a separate post.**

Section 8B.23 NO GATES OR LIGHTS Plaque (W10-13P)

Option:

- 01 The NO GATES OR LIGHTS (W10-13P) plaque (see Figure 8B-4) may be mounted below the Grade Crossing Advance Warning (W10-1 through W10-4) sign at grade crossings that are not equipped with automatic gates or automated signals.

Section 8B.24 Next Crossing Plaques (W10-14P and W10-14aP)

Option:

- 01 The NEXT CROSSING (W10-14P) plaque (see Figure 8B-4) may be mounted below the Low Ground Clearance (W10-5) sign (see Section 8B.16) or Skewed Crossing (W10-12) sign to indicate to a road user that the warning is associated with the next grade crossing. This plaque may be used where multiple grade crossings exist in close proximity to one another.
- 02 Where recommended by a Diagnostic Team, the USE NEXT CROSSING (W10-14aP) plaque (see Figure 8B-4) may be mounted below the Low Ground Clearance (W10-5) sign (see Section 8B.16) to advise a road user with a low clearance load to use the crossing after the upcoming crossing to avoid encountering a low ground clearance situation.

Section 8B.25 ROUGH CROSSING Plaque (W10-15P)

Option:

- 01 The ROUGH CROSSING (W10-15P) plaque (see Figure 8B-4) may be mounted below the Grade Crossing Advance Warning (W10-1 through W10-4) sign on the approach to a grade crossing to provide supplemental information that the surface or condition of the grade crossing might require a reduced speed or some other appropriate action by the road user.
- 02 If the grade crossing is rough, word message signs such as BUMP, DIP, or ROUGH CROSSING may be installed. A W13-1P advisory speed plaque may be installed below the word message sign in advance of rough crossings.

Section 8B.26 Light Rail Transit Station Sign (I3-8)

Option:

- 01 The Light Rail Transit Station (I3-8) sign (see Section 2H.01) may be used to direct road users to an LRT station or boarding location. It may be supplemented by the name of the transit system and by arrows as provided in Section 2D.08.

Section 8B.27 Emergency Notification System Sign (I13-1)

Standard:

- 01 The Emergency Notification System (I13-1) sign (see Figure 8B-5) shall be installed on each approach at all highway-rail grade crossings, and at all highway-LRT grade crossings with automatic gates or flashing light-signals, to provide information to road users so that they can notify the railroad company or transit agency about emergencies or malfunctioning traffic control devices.
- 02 At a highway-rail grade crossing, the Emergency Notification System sign shall, at a minimum, include the USDOT grade crossing inventory number and the emergency contact telephone number.
- 03 Where Emergency Notification System signs are used at a highway-LRT grade crossing, they shall, at a minimum, include a unique crossing identifier and the emergency contact telephone number.
- 04 The minimum width of the Emergency Notification System sign shall be 12 inches and the minimum height shall be 9 inches. The lettering on Emergency Notification System signs for the telephone number, the grade crossing inventory number, and the explanation of the purpose of the sign shall be composed of numerals and upper-case letters that are at least 1 inch in height.
- 05 Emergency Notification System signs shall be retroreflective.
- 06 Except as provided in Paragraph 7 of this Section, Emergency Notification System signs shall have a white legend and border on a blue background.

Option:

- 07 The seven-character grade crossing inventory number may be shown on the sign as a black legend on a white rectangular background.

Guidance:

- 08 *Except as provided in Paragraph 12 of this Section, Emergency Notification System signs should be attached to the Crossbuck Assemblies or grade crossing signal masts on the right-hand side of each roadway approach to the grade crossing rather than on the railroad or LRT signal control equipment housings. Emergency Notification System signs should be oriented so the face of the sign is approximately parallel or approximately perpendicular to the edge of the roadway or pathway and is visible to road users or pathway users. The visibility of the Emergency Notification System sign should not be obstructed by automatic gates in either the vertical or horizontal position.*
- 09 *The Emergency Notification System signs should be positioned so as to not obstruct any traffic control devices or limit the view of rail traffic approaching the grade crossing.*
- 10 *Emergency Notification System signs mounted on Crossbuck Assemblies or signal masts should only be large enough to provide the necessary contact information. Use of larger signs on Crossbuck Assemblies or signal masts that might obstruct the view of rail traffic or other motor vehicles should be avoided.*
- 11 *At station crossings, Emergency Notification System signs or information should be posted in a conspicuous location.*

Option:

- 12 Emergency Notification System signs may be located on a separate post. Where located on a separate post, the size of the Emergency Notification System sign may be increased for improved visibility.
- 13 Where the improvement of the conspicuity of an Emergency Notification System sign is desired, a solid yellow rectangular header panel with a legend of "NOTICE" in black letters may be used (see Section 2A.11).
- 14 Additional Emergency Notification System signs may be installed at a grade crossing.

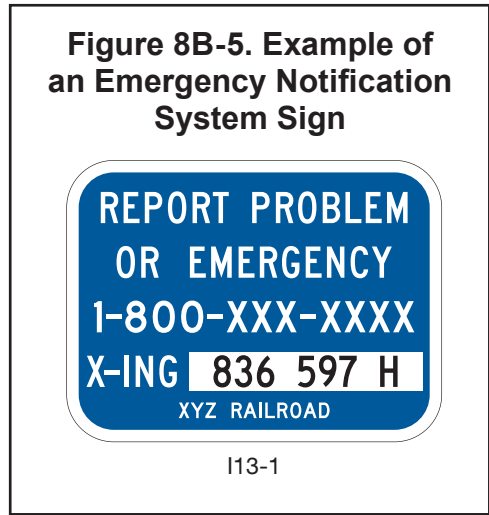

CHAPTER 8C. MARKINGS

Section 8C.01 Purpose and Application

Support:

- 01 Passive traffic control systems, consisting of signs and pavement markings only, identify and direct attention to the location of a grade crossing and advise road users to reduce their speed or stop at the grade crossing as necessary in order to yield to any rail traffic occupying, or approaching and in proximity to, the grade crossing.
- 02 Signs and pavement markings regulate, warn, and guide the road users so that they, as well as LRT vehicle operators on mixed-use alignments, can take appropriate action when approaching a grade crossing.
- 03 Unless otherwise provided in this Chapter, the provisions of Part 3 are applicable to the design and location of pavement markings at grade crossings.

Section 8C.02 Grade Crossing Pavement Markings

Standard:

- 01 **On paved roadways, grade crossing pavement markings shall consist of an X, the letters RR, a no-passing zone marking (on two-lane, two-way highways with center line markings in compliance with Section 3B.01), and certain transverse lines as shown with detailed dimensions in Figure 8C-1 and 8C-2.**
- 02 **Except as provided in Paragraphs 3 and 4 of this Section, grade crossing pavement markings shall be placed in each approach lane on all paved approaches to highway-rail grade crossings where signals or automatic gates are located, and at all other grade crossings where the posted or statutory highway speed is 40 mph or higher.**
- 03 **Grade crossing pavement markings shall not be required at highway-rail grade crossings where the posted or statutory highway speed is less than 40 mph if the Diagnostic Team determines that other installed devices provide suitable warning and control.**
- 04 **Grade crossing pavement markings shall not be required at highway-rail grade crossings in urban areas if the Diagnostic Team determines that other installed devices provide suitable warning and control.**
- 05 **Grade crossing pavement markings shall be placed in each approach lane on all paved approaches to highway-LRT grade crossings where a Crossbuck sign is placed at the grade crossing.**
- 06 **If grade crossing pavement markings are used on a multi-lane approach to a grade crossing, identical markings shall be placed in each approach lane that crosses the tracks.**
- 07 **All grade crossing pavement markings shall be retroreflective white. All other markings shall be in accordance with Part 3.**

Guidance:

- 08 *Where grade crossing pavement markings are used, a portion of the X symbol should be directly opposite the Grade Crossing Advance Warning sign.*

Option:

- 09 Where determined by the Diagnostic Team, supplemental pavement marking symbol(s) may be placed between the Grade Crossing Advance Warning sign and the grade crossing.

Guidance:

- 10 *If supplemental pavement marking symbol(s) are placed between the Grade Crossing Advance Warning sign and the grade crossing, the downstream transverse line should be at least 50 feet upstream from the stop or yield line at the grade crossing.*

Figure 8C-1. Example of Placement of Warning Signs and Pavement Markings at Grade Crossings

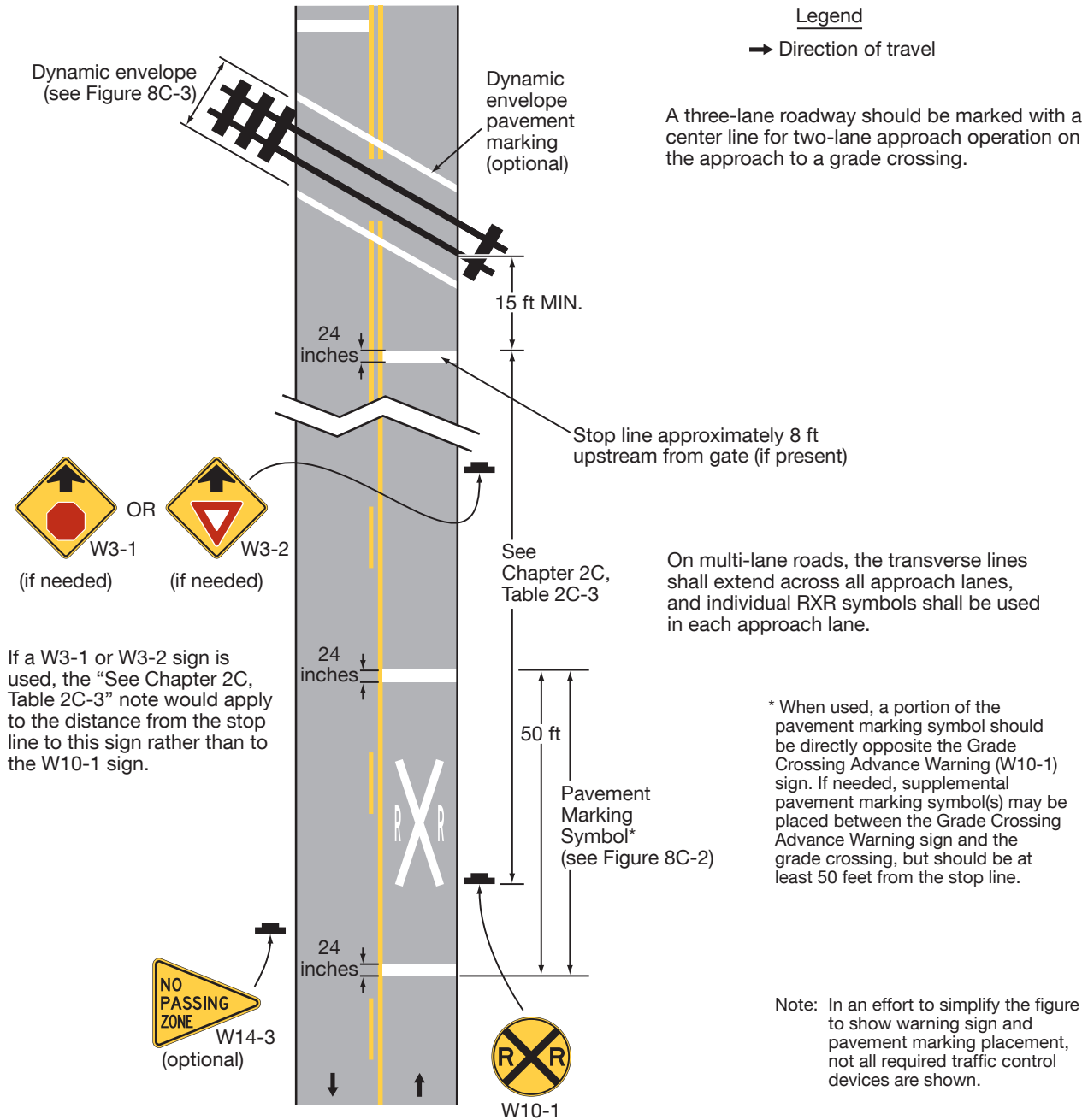
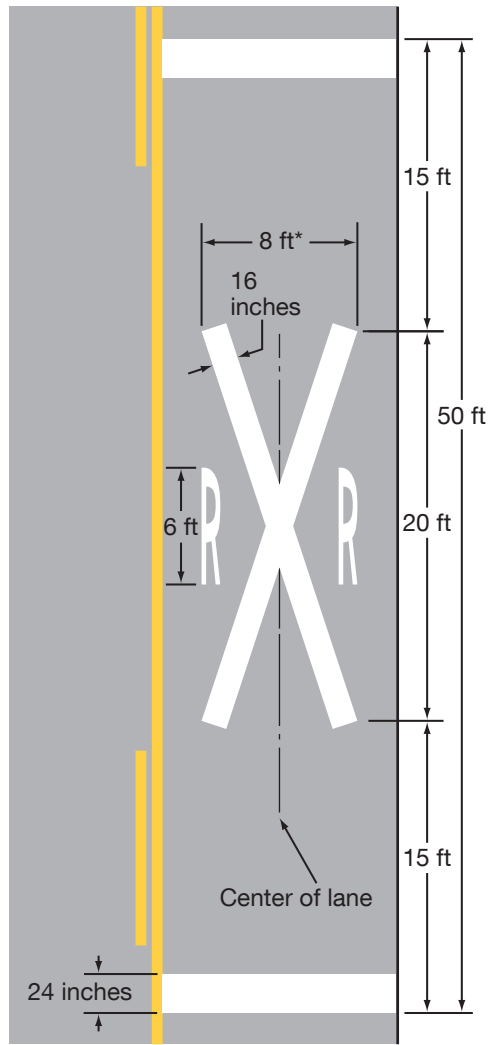

Figure 8C-2. Grade Crossing Pavement Markings

A – Grade crossing pavement marking symbol



*Width may vary according to lane width

B – Grade crossing alternative (narrow) pavement marking symbol

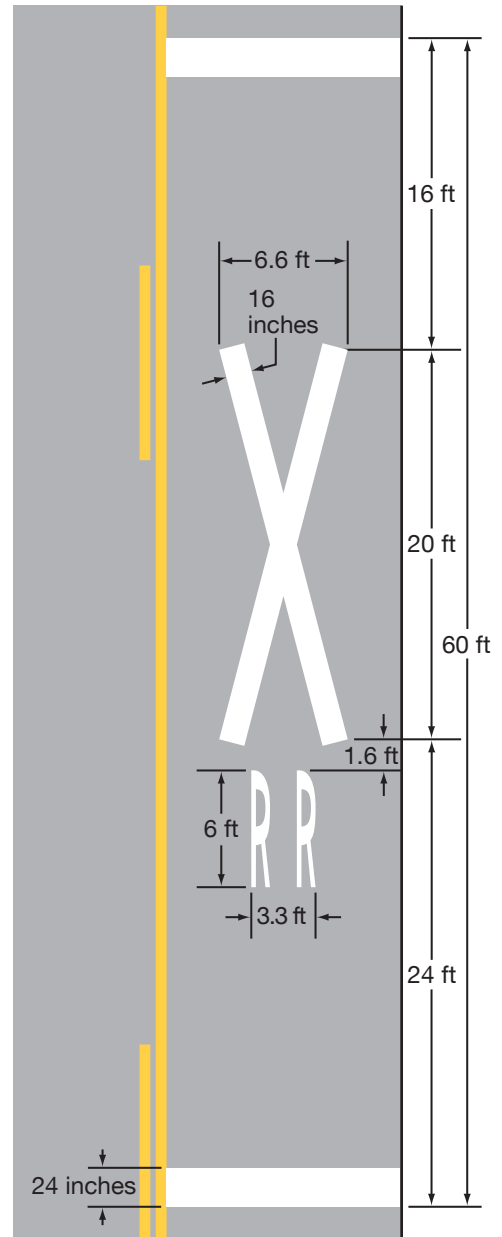

Note: Refer to Figure 8C-1 for placement

Section 8C.03 Stop Lines

Guidance:

- 01 *On paved roadway approaches to passive grade crossings where a STOP sign is installed in conjunction with the Crossbuck sign, a stop line should be installed to indicate the point behind which motor vehicles are required to stop or as near to that point as practicable.*

Option:

- 02 *On paved roadway approaches to passive grade crossings where a YIELD sign is installed in conjunction with the Crossbuck sign, a stop line may be installed to indicate the point behind which motor vehicles are required to yield or stop or as near to that point as practicable.*

Guidance:

- 03 *If a stop line is used at a passive grade crossing, it should be a transverse line at a right angle to the traveled way and should be placed no closer than 15 feet in advance of the nearest rail.*

Standard:

- 04 **On paved roadways at grade crossings that are equipped with active control devices such as flashing-light signals, automatic gates, or traffic control signals, a stop line (see Section 3B.19) shall be installed to indicate the point behind which motor vehicles are or might be required to stop.**

Guidance:

- 05 *If a stop line is used at an active grade crossing where road users are controlled by flashing-light signals, it should be a transverse line at a right angle to the traveled way and should be placed approximately 8 feet in advance of the flashing-light signals or automatic gate (if present), whichever is farther from the track(s), but no closer than 15 feet in advance of the nearest rail (see Figure 8C-1).*
- 06 *If a stop line is used at an active grade crossing where road users are controlled by a traffic control signal, it should be a transverse line at a right angle to the traveled way and should be placed no closer than 15 feet in advance of the nearest rail.*

Standard:

- 07 **If a stop line is used at an active grade crossing where road users are controlled by a traffic control signal, it shall be placed such that the lateral and longitudinal positions of the signal faces for the approach comply with the provisions of Sections 4D.07 and 4D.08.**

Section 8C.04 Lane-Use Arrow Markings

Standard:

- 01 **Lane-use arrow markings (see Section 3B.23) that indicate that a turning movement must be made or is permitted to be made from a lane that crosses a grade crossing shall not be placed between the stop line for the grade crossing and the track(s).**

Guidance:

- 02 *Lane-use arrow markings that indicate that a turning movement must be made or is permitted to be made from a lane that crosses a grade crossing should not be placed less than 100 feet upstream from the stop line for the grade crossing or less than 20 feet beyond the farthest rail.*

Section 8C.05 Edge Lines, Lane Lines, Center Lines, Raised Pavement Markers, and Tubular Markers

Guidance:

- 01 *Except as provided in Paragraphs 3 through 5 of this Section, if edge lines (see Section 3B.09), lane lines (see Section 3B.06), or center lines (see Section 3B.01) are used on an approach to a grade crossing, the edge lines, lane lines, and center lines should extend up to and across the grade crossing to reduce the likelihood that road users might inadvertently turn into the track area.*
- 02 *If crossing surface maintenance or highway approach maintenance is performed that alters the markings, the removal or replacement of the markings, raised pavement markers, and/or tubular markers should be coordinated with the road authority and the railroad company or transit agency.*

Option:

- 03 *Edge lines, lane lines, and center lines may be omitted on or between the rails to conform to the requirements of the railroad company and/or transit agency.*

- 04 Edge lines, lane lines, and center lines may be omitted on or between the rails where the highway profile is sufficiently abrupt to create a hang-up situation for pavement marking equipment with low ground clearance.
- 05 The edge lines, lane lines, and center lines may be omitted from the highway surface at a grade crossing if the surface cannot retain the application of the edge line, lane line, or center line marking.
- 06 If recommended by a Diagnostic Team, raised pavement markers (see Section 3B.16) may be used to supplement the edge lines, lane lines, or center lines that extend up to and across the grade crossing.
- 07 If recommended by a Diagnostic Team, tubular markers (see Section 3I.02) may be used to supplement the edge lines that extend up to and across the grade crossing.

Guidance:

- 08 *Tubular markers should be installed in accordance with the clearance requirements of the railroad company and/or transit agency.*

Standard:

- 09 **The color under both daytime and nighttime conditions of raised pavement markers or tubular markers that are used at a grade crossing shall be the same color as the edge line, lane line, or center line that they supplement.**

Section 8C.06 Dynamic Envelope and Do Not Block Pavement Markings

Option:

- 01 Dynamic envelope markings may be installed at a grade crossing to mark the edges of the train dynamic envelope.

Standard:

- 02 **If used, pavement markings for indicating the dynamic envelope shall comply with the provisions of Part 3 and shall be a solid white line not less than 4 inches nor greater than 24 inches in width.**

Option:

- 03 Contrasting pavement color (see Section 3A.03 and Chapter 3H) and/or contrasting pavement texture may be used alone or in combination with pavement markings to indicate the dynamic envelope.

Guidance:

- 04 *If a solid white line is used to convey the dynamic envelope, the line should be placed completely outside of the dynamic envelope. If used, dynamic envelope pavement markings should be placed parallel to the nearest rail in accordance with the railroad company or transit agency requirements. If used, dynamic envelope pavement markings should extend across the roadway as shown in Figure 8C-3. Dynamic envelope pavement markings should not be placed perpendicular to the roadway at skewed grade crossings.*

Option:

- 05 If solid white lines are used to indicate the dynamic envelope, white cross-hatching lines (see Figure 8C-3) may also be placed on the highway pavement within the dynamic envelope as a supplement to, but not as a substitute for, the solid white lines. White cross-hatching lines (see Section 3B.26) may also be placed on the pavement to mark areas adjacent to the dynamic envelope where vehicles are not intended to stop or stand as shown in Figure 8C-4.
- 06 In semi-exclusive LRT alignments, the dynamic envelope markings may be along the LRT trackway between intersections where the trackway is immediately adjacent to travel lanes and no physical barrier is present.
- 07 In mixed-use LRT alignments, the dynamic envelope markings may be continuous between intersections (see Figure 8C-5).
- 08 In mixed-use LRT alignments, pavement markings for adjacent travel or parking lanes may be used instead of dynamic envelope markings if the lines are outside the dynamic envelope.

Figure 8C-3. Example of Dynamic Envelope Pavement Markings at Grade Crossings

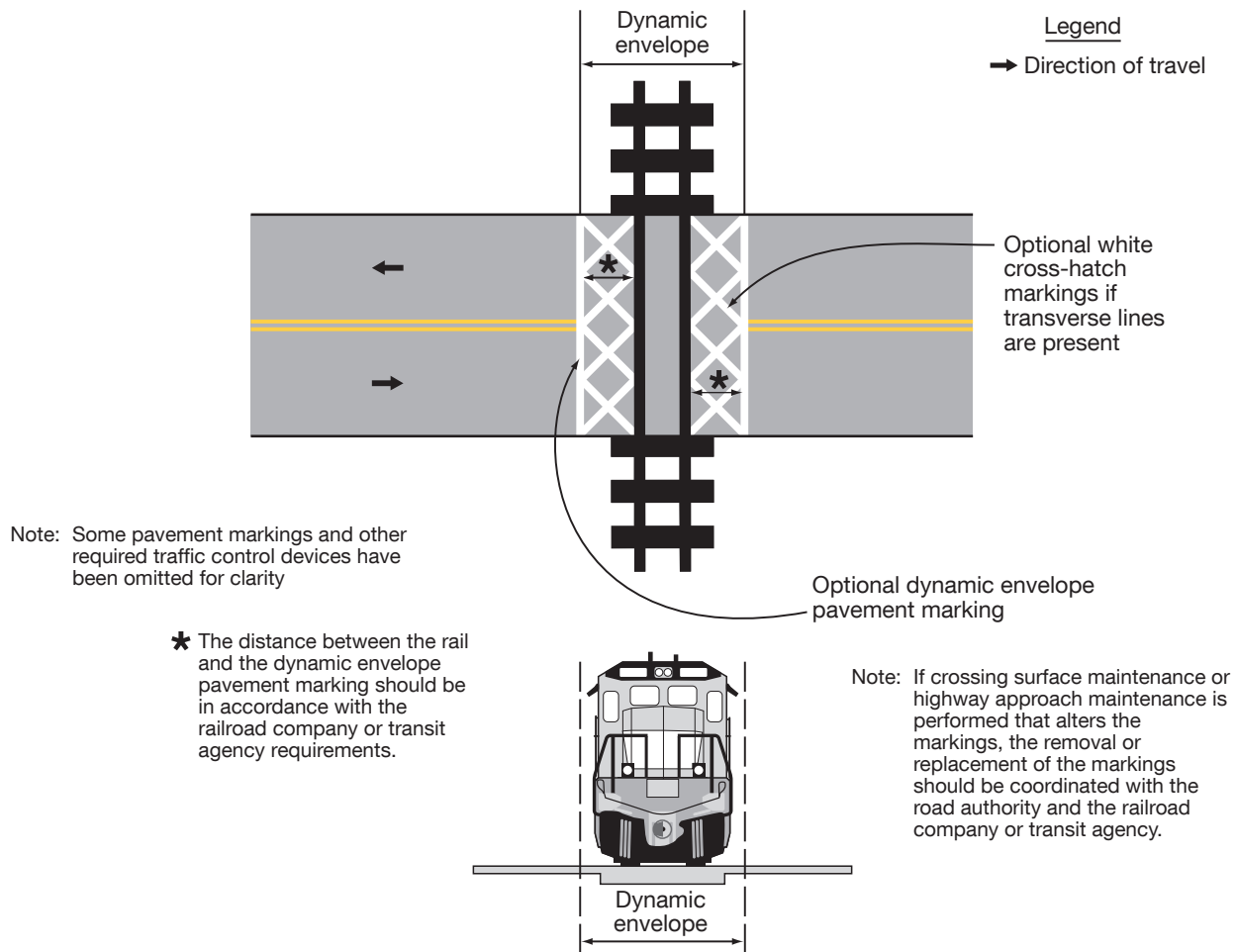

Figure 8C-4. Example of Dynamic Envelope and Do Not Block Pavement Markings at Grade Crossings

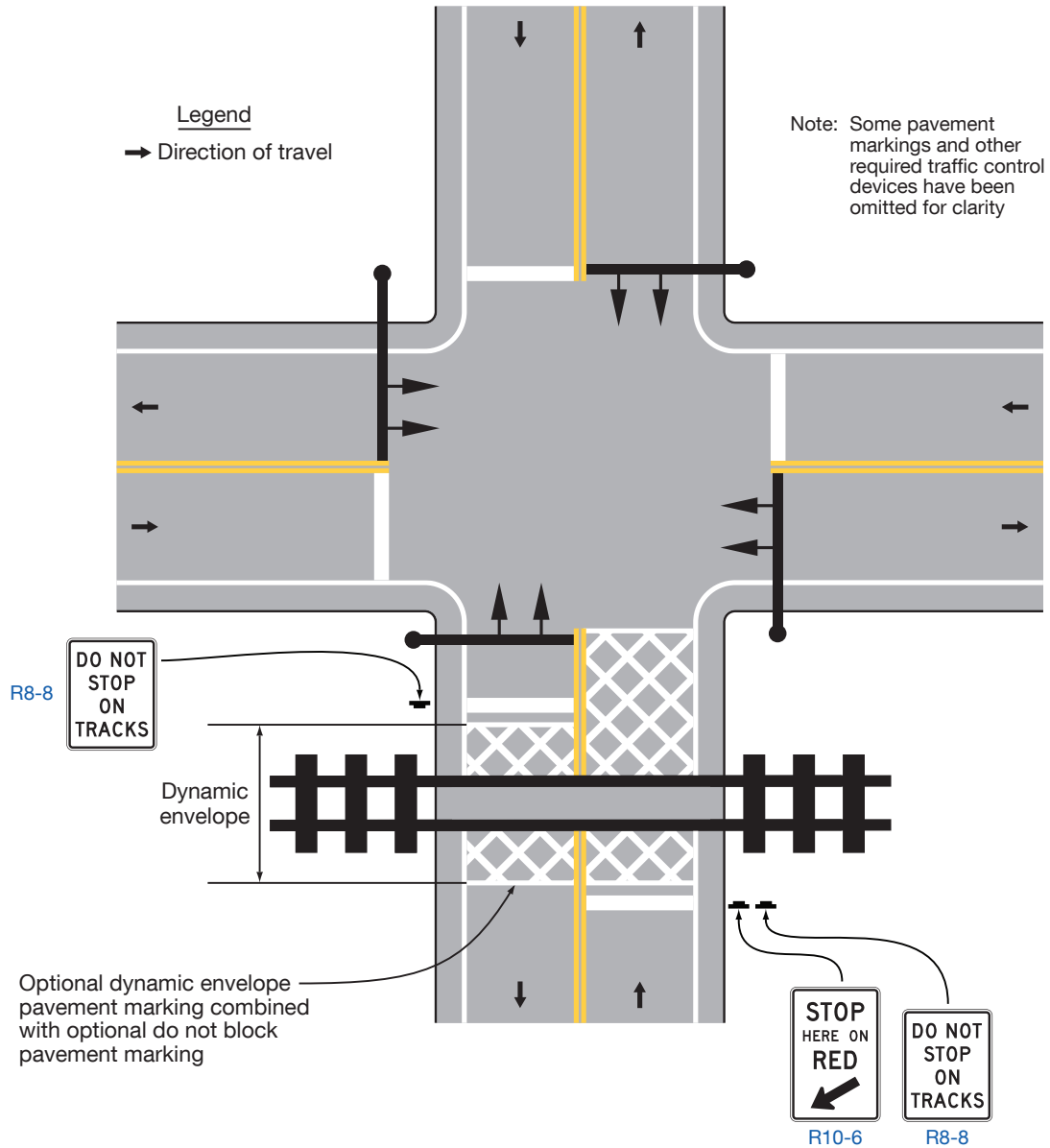
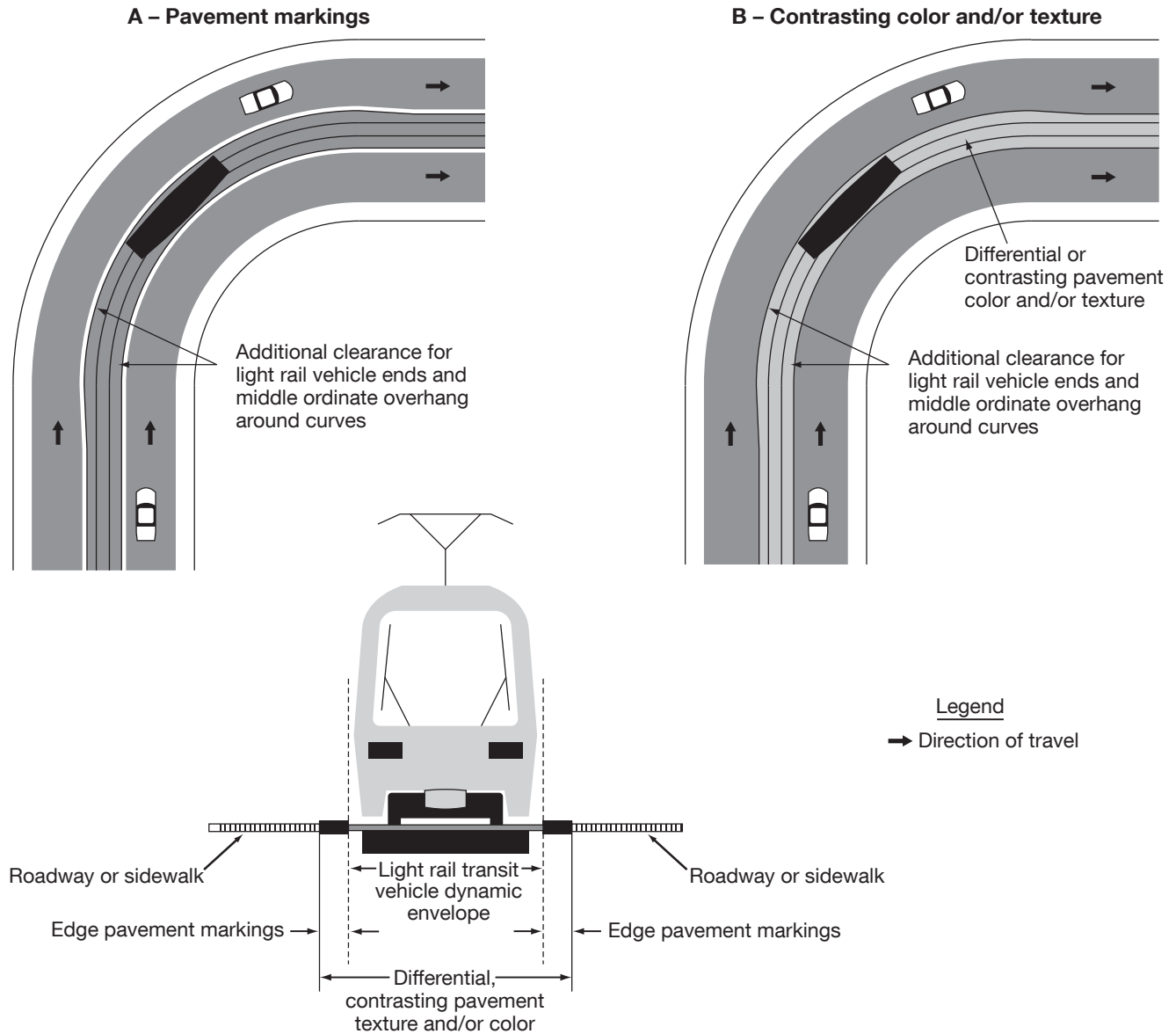

Figure 8C-5. Examples of Light Rail Transit Vehicle Dynamic Envelope Markings for Mixed-Use Alignments



CHAPTER 8D. FLASHING-LIGHT SIGNALS, AUTOMATIC GATES, AND TRAFFIC CONTROL SIGNALS

Section 8D.01 Introduction

Support:

- 01 Active traffic control systems inform road users of the approach or presence of rail traffic at grade crossings. These systems include Exit Gate systems, automatic gates, flashing-light signals, traffic control signals, actuated blank-out and variable message signs, and other active traffic control devices that are used in conjunction with the signs and pavement markings that are described in Chapters 8B and 8C, respectively.
- 02 Figure 8D-1 shows a post-mounted flashing-light signal (two light units mounted in a horizontal line), a flashing-light signal mounted on an overhead structure, and an automatic gate assembly.
- 03 Where LRT speed is cited in this Part, it refers to the maximum speed at which LRT equipment is permitted to traverse a particular grade crossing.

Option:

- 04 Post-mounted and overhead flashing-light signals may be used separately or in combination with each other as determined by the Diagnostic Team. Also, flashing-light signals may be used without automatic gate assemblies, as determined by the Diagnostic Team.

Standard:

- 05 **The meaning of flashing-light signals and automatic gates shall be as stated in the [Texas Transportation Code Ch. 545, Subch. F](#).**
- 06 **Location for flashing-light signals and automatic gates shall be as shown in Figure 8D-1.**
- 07 **Where there is a curb, a horizontal offset of at least 2 feet shall be provided from the face of the vertical curb to the nearest part of the signal or automatic gate arm in its upright position. Where a cantilevered-arm flashing-light signal is used, the vertical clearance shall be at least 17 feet above the crown of the highway to the lowest point of the signal unit.**
- 08 **Where there is a shoulder, but no curb, a horizontal offset of at least 2 feet from the edge of a paved shoulder shall be provided, with an offset of at least 6 feet from the edge of the traveled way.**
- 09 **Where there is no curb or shoulder, the minimum horizontal offset shall be 6 feet from the edge of the traveled way.**
- 10 **Minimum clearance dimensions for flashing-light signals and automatic gates relative to the closest track shall conform to standards provided by the railroad company and/or transit agency, and the regulatory agency with statutory authority (if applicable).**

Guidance:

- 11 *Equipment housings (controller cabinets) should have a lateral offset of at least 30 feet from the edge of the highway, and where railroad or LRT property and conditions allow, at least 25 feet from the nearest rail.*
- 12 *If a pedestrian route is provided, sufficient clearance from supports, posts, and automatic gate mechanisms should be maintained for pedestrian travel.*
- 13 *Where determined by the Diagnostic Team, a lateral escape route to the right-hand side of the highway in advance of the grade crossing traffic control devices should be kept free of guardrail or other ground obstructions. Where guardrail is not deemed necessary or appropriate, barriers should not be used for protecting signal supports.*
- 14 *The same lateral offset and roadside safety features should apply to flashing-light signal and automatic gate locations on both the right-hand and left-hand sides of the roadway.*

Option:

- 15 In industrial or other areas involving only low-speed highway traffic or where signals are vulnerable to damage by turning truck traffic, guardrail may be installed to provide protection for the signal assembly.

Guidance:

- 16 *Where both traffic control signals and flashing-light signals (with or without automatic gates) are in operation at the same highway-LRT grade crossing, the operation of the devices should be coordinated to avoid any display of conflicting signal indications.*

Option:

- 17 If highway traffic signals must be located within close proximity to the flashing-light signals, the highway traffic signals may be mounted on the same overhead structure as the flashing-light signals.

Section 8D.02 Flashing-Light Signals

Support:

- 01 Section 8D.04 contains additional information regarding flashing-light signals at highway-LRT grade crossings in semi-exclusive and mixed-use alignments.

Standard:

- 02 **If used, the flashing-light signal assembly (shown in Figure 8D-1) on the side of the highway shall include a standard Crossbuck (R15-1) sign, and where there is more than one track, a supplemental Number of Tracks (R15-2P) plaque, all of which indicate to motorists, bicyclists, and pedestrians the location of a grade crossing.**

Guidance:

- 03 *The bottom of the Number of Tracks (R15-2P) plaque (when used) should be located as low as practicable above the flashing-light backgrounds. The Crossbuck (R15-1) sign should be located just above the Number of Tracks (R15-2P) plaque or, if no plaque is present, the bottom of the Crossbuck sign should be located as low as practicable above the flashing-light backgrounds.*

Support:

- 04 Additional information regarding sizes and clearances of components used on flashing-light signals can be found in Part 3 of the “2023 AREMA Communications and Signals Manual” published by the American Railway Engineering and Maintenance-of-Way Association (AREMA).

Option:

- 05 At highway-rail grade crossings, bells or other audible warning devices may be included in the assembly and may be operated in conjunction with the flashing-light signals to provide additional warning for pedestrians, bicyclists, and/or other non-motorized road users.

Standard:

- 06 **When indicating the approach or presence of rail traffic, the flashing-light signal shall display toward approaching highway traffic two red lights mounted in a horizontal line flashing alternately.**
- 07 **If used, flashing-light signals shall be placed to the right-hand side of approaching highway traffic on all highway approaches to a grade crossing. They shall be located laterally with respect to the highway in compliance with Figure 8D-1 except where such location would adversely affect signal visibility.**
- 08 **If used at a grade crossing with highway traffic in both directions, back-to-back flashing-light signals shall be placed on each side of the tracks. On multi-lane one-way streets and divided highways, flashing-light signals shall be placed on the approach side of the grade crossing on both sides of the roadway or shall be placed above the highway.**
- 09 **Each red signal unit in the flashing-light signal shall flash alternately. The number of flashes per minute for each lamp shall be 35 minimum and 65 maximum. Each lamp shall be illuminated for approximately the same length of time. The total time of illumination of each pair of lamps shall be the entire operating time.**
- 10 **Flashing-light units shall use either 8-inch or 12-inch nominal diameter lenses.**

Guidance:

- 11 *In choosing between the 8-inch or 12-inch nominal diameter lenses for use in grade crossing flashing-light signals, consideration should be given to the principles stated in Section 4E.02.*
- 12 *If flashing-light signals are used, at least one pair of flashing lights should be provided for each approach lane of the roadway.*
- 13 *The center-to-center distance between the two red lights in a flashing-light unit should be approximately 30 inches.*
- 14 *The mounting height of the flashing-light units, measured from the center of the flashing-light unit housing to the elevation of the crown of the roadway, should be between 8 feet and 9 feet .*
- 15 *The top of the support pole foundation should be no more than 4 inches above the surface of the ground and should be at the same elevation as the crown of the roadway.*

Standard:

- 16 **Grade crossing flashing-light signals shall operate at a low voltage using storage batteries either as a primary or stand-by source of electrical energy. Provision shall be made to provide a source of energy for charging batteries.**

Option:

- 17 Additional flashing-light signals may be mounted on the same supporting post and directed toward vehicular traffic approaching the grade crossing from other than the principal highway route, such as where there are approaching routes on highways closely adjacent to and parallel to the track(s).

Guidance:

- 18 *Where the storage distance for vehicles approaching a grade crossing is less than a design vehicle length, the Diagnostic Team should consider providing additional flashing-light signals aligned toward the movement turning toward the grade crossing.*
- 19 *The Diagnostic Team should consider the use of additional flashing-light signals to provide supplemental warning to pedestrians, especially on one-way streets and divided highways.*

Standard:

- 20 **References to lenses in this Section shall not be used to limit flashing-light signal optical units to incandescent lamps within optical assemblies that include lenses.**

Support:

- 21 Research has resulted in flashing-light signal optical units that are not lenses, such as, but not limited to, light-emitting diode (LED) flashing-light signal modules.

Option:

- 22 If a Diagnostic Team determines that it is appropriate, the flashing-light signals may be installed on overhead structures or cantilevered supports as shown in Figure 8D-1 where needed for additional emphasis, or for better visibility to approaching traffic, particularly on multi-lane approaches or highways with profile restrictions.
- 23 If it is determined by a Diagnostic Team that one flashing-light signal on the cantilever arm is not sufficiently visible to road users, one or more additional flashing-light signals may be mounted on the supporting post and/or on the cantilever arm.

Standard:

- 24 **Breakaway or frangible bases shall not be used on the supporting posts for overhead structures or cantilevered arms that support overhead flashing-light signals.**

Section 8D.03 Automatic Gates**Support:**

- 01 An automatic gate is a traffic control device used in conjunction with flashing-light signals.

Standard:

- 02 **The automatic gate (see Figure 8D-1) shall consist of a drive mechanism and a fully retroreflective red-and-white-striped gate arm with lights. When in the down position, the gate arm shall extend across the approaching lanes of highway traffic.**
- 03 **In the normal sequence of operation, unless constant warning time detection or other advanced system requires otherwise, the flashing-light signals and the lights on the gate arm (in its normal upright position) shall be activated immediately upon detection of approaching rail traffic. The gate arm shall start its downward motion not less than 3 seconds after the flashing-light signals start to operate, shall reach its horizontal position at least 5 seconds before the arrival of the rail traffic, and shall remain in the down position until the rail traffic completely clears the grade crossing.**
- 04 **When the rail traffic clears the grade crossing, and if no other rail traffic is detected, the gate arm shall ascend to its upright position, following which the flashing-light signals and the lights on the gate arm shall cease operation.**
- 05 **Gate arms shall be fully retroreflective on both sides and shall have vertical stripes alternately red and white at 16-inch intervals measured horizontally. The width (which becomes the height of the retroreflective sheeting when the automatic gate is in the down position) of the retroreflective sheeting on the front of the gate arm shall be at least 4 inches for the first 32 feet of gate arm length measured from the center of the gate mast. The front of the gate arm beyond 32 feet to the tip of the gate shall have retroreflective sheeting at least 2 inches in width. (See FHWA Known Errors 01/24/2025)**

Support:

- 06 It is acceptable to replace a damaged gate arm with a gate arm having vertical stripes even if the other existing gate arms at the same grade crossing have diagonal stripes; however, it is also acceptable to replace a damaged

gate arm with a gate arm having diagonal stripes if the other existing gate arms at the same grade crossing have diagonal stripes in order to maintain consistency per the provisions of Paragraph 13 of Section 1B.03.

Standard:

07 **Gate arms shall have at least three red lights as shown in Figure 8D-1.**

08 **When activated, the gate arm light nearest the tip shall be illuminated continuously and the other lights shall flash alternately in unison with the flashing-light signals such that the left-most flashing gate arm light(s) flashes simultaneously with the left-hand light of the flashing-light signals and the right-most flashing gate arm light(s) flashes simultaneously with the right-hand light of the flashing-light signals.**

Support:

09 Typical gate arm lights are approximately 4 inches in diameter if they are circular. Rectangular gate arm lights with approximately the same illuminated surface area are sometimes used on gate arms instead of circular lights.

Standard:

10 **The entrance gate arm mechanism shall be designed to fail safe in the down position.**

Guidance:

11 *The gate arm should ascend to its upright position in 12 seconds or less.*

12 *In its normal upright position, when no rail traffic is approaching or occupying the grade crossing, the gate arm should be approximately vertical (see Figure 8D-1).*

13 *In the design of individual installations, consideration should be given to timing the operation of the gate arm to accommodate large and/or slow-moving motor vehicles.*

14 *The gate arms should cover the approaching highway to block all motor vehicles from being driven around the gate arms without crossing the center line.*

15 *The height of the gate arm when it is in the down position should be between 3.5 feet and 4.5 feet above the crown of the roadway. When the gate arm is in the down position, no portion of the counterweight should extend into the traveled way, sidewalk, or pathway.*

Option:

16 Channelizing devices and/or raised median islands may be used to discourage driving around lowered automatic gates.

Guidance:

17 *Where sufficient space is available, median islands should be at least 60 feet in length.*

Option:

18 Where automatic gates are located in the median, additional median width may be required to provide the minimum clearance for the counterweight supports.

19 Automatic gates may be supplemented by cantilevered flashing-light signals (see Figure 8D-1) where there is a need for additional emphasis or better visibility.

Section 8D.04 Use of Active Traffic Control Systems at LRT Grade Crossings

Standard:

01 **At highway-LRT grade crossings where LRT speeds exceed 25 mph, active traffic control systems (see Section 8D.01) shall be used.**

02 **At highway-LRT grade crossings where LRT speeds exceed 40 mph, the active traffic control system shall include automatic gates.**

Option:

03 The Diagnostic Team may recommend an active traffic control system with automatic gates at highway-LRT grade crossings where LRT speeds do not exceed 40 mph.

Guidance:

04 *At highway-LRT grade crossings where LRT speeds are 25 mph or less, active traffic control systems should be used unless the Diagnostic Team determines that the use of Crossbuck Assemblies, STOP signs alone, or YIELD signs alone would be adequate.*

05 *Where the highway-LRT grade crossing is at a location other than an intersection and LRT speeds exceed 20 mph, traffic control signals should not be used in lieu of flashing-light signals.*

Support:

06 Sections 8D.02 and 8D.03 contain additional provisions regarding the design and operation of flashing-light signals and automatic gates, respectively.

Standard:

07 **If flashing-light signals are in operation at a highway-LRT crossing that is used by pedestrians, bicyclists, and/or other non-motorized road users, an audible device such as a bell shall also be provided and shall be operated in conjunction with the flashing-light signals.**

Section 8D.05 Exit Gate and Four-Quadrant Gate Systems

Option:

01 Exit Gate systems may be installed to improve safety at grade crossings where a Diagnostic Team determines that less restrictive measures, such as automatic gates and median islands, are not effective.

Support:

02 A grade crossing that includes exit gates on some, but not all, of the exiting lanes is an Exit Gate system, but is not considered to be a Four-Quadrant Gate system.

03 The term Four-Quadrant Gate system is used in a generic sense in that it refers to the fact that all entrances and exits from a grade crossing are controlled by automatic gates in order to provide a full closure to all entering and exiting lanes. The term Four-Quadrant Gate system does not refer to the number of gates installed, but rather the fact that a full closure is provided.

Standard:

04 **The Exit Gate system shall use a series of automatic gates with fully retroreflective red-and-white-striped gate arms with lights, and when in the down position the gate arms extend individually across the entrance and exit lanes of the roadway as shown in Figure 8D-2. The provisions contained in Section 8D.02 for flashing-light signals shall be followed for signal specifications, location, and clearance distances.**

05 **Gate arm design, colors, and lighting requirements shall be in accordance with the provisions contained in Section 8D.03.**

Support:

06 The provisions contained in Section 8D.03 for automatic gates are applicable to exit gates.

Standard:

07 **In the normal sequence of operation, unless constant warning time detection or other advanced system requires otherwise, the flashing-light signals and the lights on the gate arms (in their normal upright positions) shall be activated immediately upon the detection of approaching rail traffic. The entrance gate arms shall start their downward motion not less than 3 seconds after the flashing-light signals start to operate and shall reach their horizontal position at least 5 seconds before the arrival of the rail traffic. Exit gate arm activation and downward motion shall be based on detection or timing requirements established by a Diagnostic Team. If an Exit Gate system is present, the queue exit gate clearance time (see AREMA Manual) shall be long enough to permit the exit gate arm to lower after a design vehicle of maximum length is clear of the minimum track clearance distance (see Section 8A.07). The gate arms shall remain in the down position as long as the rail traffic occupies the grade crossing. (See FHWA Known Errors 01/24/2025)**

08 **When the rail traffic clears the grade crossing, and if no other rail traffic is detected, the gate arms shall ascend to their upright positions, following which the flashing-light signals and the lights on the gate arms shall cease operation.**

09 **Except as provided in Paragraph 21 of this Section, the exit gate arm mechanism shall be designed to fail-safe in the up position.**

10 **At locations where gate arms are offset a sufficient distance for motor vehicles to drive between the entrance and exit gate arms, median islands (see Figure 8D-2) shall be installed in accordance with the needs determined by the Diagnostic Team.**

Guidance:

11 *The gate arm should ascend to its upright position in 12 seconds or less.*

12 *Constant warning time detection circuits should be used with Exit Gate systems where practical.*

13 *The operating mode of the exit gates should be determined by a Diagnostic Team.*

- 14 *If the Timed Exit Gate Operating Mode is used, the Diagnostic Team should also determine the Exit Gate Clearance Time (see definition in Section 1C.02).*
- 15 *If the Dynamic Exit Gate Operating Mode is used, highway vehicle intrusion detection devices that are part of a system that incorporates processing logic to detect the presence of motor vehicles within the minimum track clearance distance (see Section 8A.07) should be installed to control exit gate operation. Exit gates should be independently controlled for each direction of roadway traffic.*
- 16 *Regardless of which exit gate operating mode is used, the Exit Gate Clearance Time should be considered when determining additional time requirements for the Minimum Warning Time.*

Support:

- 17 The minimum warning time is the least amount of time that active warning devices operate prior to the arrival of rail traffic at a grade crossing.

Guidance:

- 18 *If an Exit Gate system is used at a location that is adjacent to an intersection that could cause motor vehicles to queue within the minimum track clearance distance (see Section 8A.07), the Dynamic Exit Gate Operating Mode should be used unless the Diagnostic Team determines otherwise.*
- 19 *If an Exit Gate system is interconnected with a highway traffic signal (see Section 8D.09), back-up or standby power should be considered for the highway traffic signal. Also, circuitry should be installed to prevent the highway traffic signal from leaving the track clearance green interval until all of the gates are lowered.*
- 20 *Exit Gate systems should include remote health (status) monitoring capable of automatically notifying railroad or LRT signal maintenance personnel when anomalies have occurred within the system.*

Option:

- 21 Exit gate arms may fail in the down position if the grade crossing is equipped with remote health (status) monitoring.
- 22 Exit Gate system installations may include median islands between opposing lanes on an approach to a grade crossing.

Guidance:

- 23 *Where sufficient space is available, median islands should be at least 60 feet in length.*

Figure 8D-2. Examples of Location Plan for Flashing-Light Signals and Four-Quadrant Gates

The locations of the gates and the placement of medians or islands between the gates are to be determined by the Diagnostic Team.

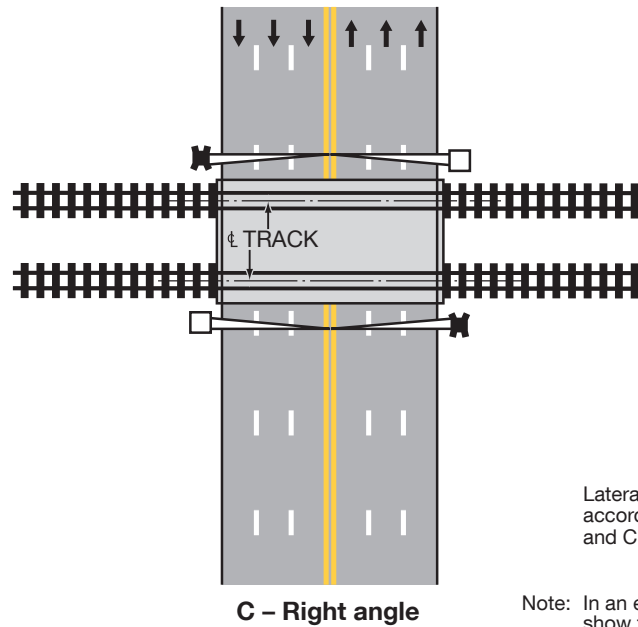
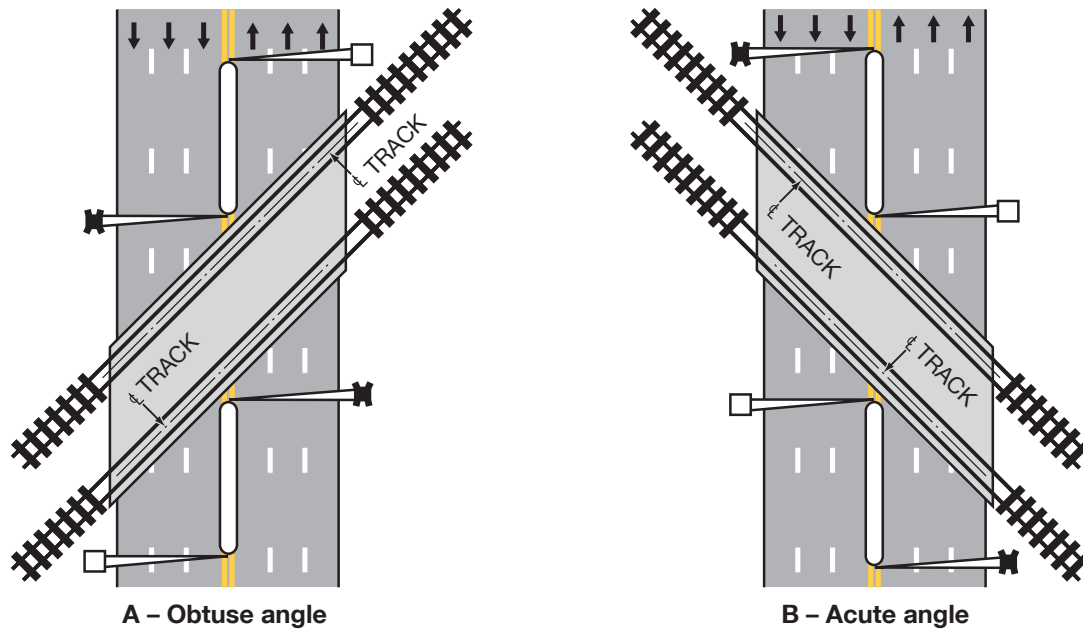

- Legend**
- Direction of travel
 - ⊞ Entrance gate
 - Exit gate

Lateral clearances shall be in accordance with Figure 8D-1 and Chapter 8D.

Note: In an effort to simplify the figure to show typical location plans for flashing-light signals and four-quadrant gates, not all traffic control devices are shown on this figure.

Section 8D.06 Wayside Horn Systems

Option:

- 01 A wayside horn system (see definition in Section 1C.02) may be installed in compliance with 49 CFR Part 222 to provide audible warning directed toward the road users at a highway-rail grade crossing or at a pathway grade crossing.

Standard:

- 02 **Wayside horn systems used at grade crossings where the locomotive horn is not sounded shall be equipped and shall operate in compliance with the requirements of Appendix E to 49 CFR Part 222.**

Guidance:

- 03 *The same lateral clearance and roadside safety features should apply to wayside horn systems as described in the provisions contained in Section 8D.01. Wayside horn systems, when mounted on a separate pole assembly, should be installed no closer than 15 feet from the center of the nearest track and should be positioned to not obstruct the motorists' line of sight of the flashing-light signals.*

Section 8D.07 Rail Traffic Detection

Standard:

- 01 **The devices employed in active traffic control systems shall be actuated by some form of rail traffic detection.**
- 02 **Rail traffic detection circuits, insofar as practical, shall be designed on the fail-safe principle.**
- 03 **Flashing-light signals shall operate for at least 20 seconds before the arrival of any rail traffic, except as provided in Paragraph 4 of this Section.**

Option:

- 04 On tracks where all rail traffic operates at less than 20 mph and where road users are directed by an authorized person on the ground to not enter the crossing at all times that approaching rail traffic is about to occupy the crossing, a shorter signal operating time for the flashing-light signals may be used.
- 05 Additional warning time may be provided when determined by an engineering study.

Guidance:

- 06 *Where the speeds of different rail traffic on a given track vary considerably under normal operation, special devices or circuits should be installed to provide reasonably uniform notice in advance of all rail traffic movements over the grade crossing. Special control features should be used to eliminate the effects of station stops and switching operations within approach control circuits to prevent excessive activation of the traffic control devices while rail traffic is stopped on or switching upon the approach track control circuits.*

Section 8D.08 Use of Traffic Control Signals at Grade Crossings

Standard:

- 01 **Except as provided in Paragraph 2 of this Section, traffic control signals shall not be used instead of flashing-light signals to control road users at a highway-rail grade crossing.**

Option:

- 02 Traffic control signals may be used instead of flashing-light signals to control road users at industrial highway-rail grade crossings and other places where the maximum speed of trains is 10 mph or less.

Support:

- 03 Sections 8D.04 and 8D.14 contain information regarding the use of traffic control signals at highway-LRT grade crossings.

Standard:

- 04 **The appropriate provisions of Part 4 relating to traffic control signal design, installation, and operation shall be applicable where traffic control signals are used instead of flashing-light signals to control road users at grade crossings.**

Section 8D.09 Preemption of Highway Traffic Signals at or Near Grade Crossings

Support:

- 01 Traffic signal preemption for grade crossings is a complex topic that requires a specific understanding of grade crossing warning systems and highway traffic signal operations. While most traffic signal operations are governed only by the traffic signal controller unit and the associated traffic signal equipment, preemption for

grade crossings is also governed by the grade crossing warning system. Active grade crossing warning systems include flashing-light signals and possibly automatic gates, as well as various types of train detection equipment. Where the traffic signal controller unit is interconnected with the grade crossing warning system for the purpose of preemption, a combined system is created. It is the combined system that requires a thorough understanding of the design and operating parameters in order to provide proper operation of the preemption system.

- 02 The Federal Railroad Administration (FRA) has issued two documents that provide additional information relating to preemption of highway traffic signals at or near grade crossings. The first document is “Technical Bulletin S-12-01, Guidance Regarding the Appropriate Process for the Inspection of Highway-Rail Grade Crossing Warning System Pre-emption Interconnections with Highway Traffic Signals” and the second document is “Safety Advisory 2010-02, Signal Recording Devices for Highway-Rail Grade Crossing Active Warning Systems that are Interconnected with Highway Traffic Signal Systems.”

Guidance:

- 03 *If a grade crossing is equipped with flashing-light signals and is located 200 feet or less from an intersection or midblock location controlled by a traffic control signal, a pedestrian hybrid beacon, or an emergency-vehicle hybrid beacon, the intersection should be provided with rail preemption in accordance with Section 4F.19 unless otherwise determined by the Diagnostic Team.*
- 04 *Coordination with the flashing-light signals, such as using queue detection and queue cutter signals, blank-out signs, or other alternatives, should be considered where a traffic control signal, a pedestrian hybrid beacon, or an emergency-vehicle hybrid beacon is located more than 200 feet from the grade crossing. Factors to be considered should include traffic volumes, highway vehicle mix, highway vehicle and train approach speeds, frequency of trains, presence of midblock driveways or unsignalized intersections, and the potential for vehicular queues resulting from an adjacent downstream grade crossing or highway traffic signal to extend into the minimum track clearance distance (see Section 8A.07).*
- 05 *The highway agency or authority with jurisdiction and the regulatory agency with statutory authority, if applicable, should jointly determine the preemption operation and the timing of highway traffic signals interconnected with grade crossings adjacent to signalized locations.*
- 06 *If a highway traffic signal is installed 200 feet or less from a passive grade crossing, unless otherwise determined by the Diagnostic Team, an active grade crossing warning system should be installed at the grade crossing to provide a means to preempt the highway traffic signal in order to clear vehicles from the minimum track clearance distance (see Section 8A.07) upon approach of rail traffic.*
- 07 *If a highway traffic signal is interconnected with flashing-light signals, the flashing-light signals should be provided with automatic gates to prevent additional vehicles from being drawn into the minimum track clearance distance (see Section 8A.07) during the track clearance interval prior to the arrival of rail traffic unless a Diagnostic Team determines otherwise.*

Support:

- 08 Regular joint inspections by the highway agency or authority with jurisdiction, the regulatory agency with statutory authority, if applicable, and the railroad company or transit agency are a best practice and typically include verification of the preemption operation, the amount of warning time and/or preemption time being provided by the grade crossing warning system, and the timing of highway traffic signals interconnected and/or coordinated with the flashing-light signals.
- 09 Section 4F.19 includes a recommendation that traffic control signals that are adjacent to highway-rail grade crossings and that are coordinated with the flashing-light signals at the grade crossing or that include railroad preemption features be provided with a back-up power supply.

Standard:

- 10 **Information regarding the type of preemption and any related timing parameters shall be provided to the railroad company or transit agency so that the railroad company or transit agency can design the appropriate train detection circuitry.**
- 11 **If preemption is provided, unless otherwise determined by a Diagnostic Team, the normal sequence of highway traffic signal indications shall be preempted upon the approach of a train to provide a track clearance interval to provide an opportunity for motor vehicles at the grade crossing to clear the minimum track clearance distance (see Section 8A.07) prior to the arrival of rail traffic.**

Option:

- 12 Where train switching or train restarts occur close to a grade crossing, the Diagnostic Team may determine that the preemption time can be reduced in accordance with the operating requirements of the railroad company and/or transit agency.

Standard:

- 13 Where flashing-light signals are in place at a grade crossing, any **traffic control signal faces or pedestrian hybrid beacon faces** installed within 50 feet of any rail shall be preempted upon the approach of rail traffic. The Diagnostic Team shall determine the signal indications displayed by the **traffic control signal faces or pedestrian hybrid beacon faces** that control movements across the grade crossing in accordance with Section 4F.19 in order to avoid the display of signal indications that conflict with the flashing-light signals.

Guidance:

- 14 Where the flashing-light signals are in place at a grade crossing, the operation of any flashing yellow beacon installed within 50 feet of any rail should be considered by a Diagnostic Team to determine whether the operation of the beacon should be terminated during the approach and passage of rail traffic.

Standard:

- 15 The preemption special control mode shall be activated by a supervised preemption interconnection using fail-safe design principles between the control circuits of the grade crossing warning system and the traffic signal controller unit. The approach of rail traffic to a grade crossing shall de-energize the interconnection or send a message via a fail-safe data communication protocol (such as the “IEEE Standard for the Interface Between the Rail Subsystem and the Highway Subsystem at a Highway Rail Intersection,” 1570-2002 (R2008), Institute of Electrical and Electronics Engineers), which in turn shall activate the traffic signal controller preemption sequence. This shall establish and maintain the preemption condition during the time the grade crossing warning system is activated, except that when automatic gates exist, the preemption condition shall not be terminated until the automatic gates are energized to start their upward movement.

Support:

- 16 Advance preemption is the notification of approaching rail traffic that is forwarded to the highway traffic signal controller unit or assembly by the railroad or light rail transit equipment in advance of the activation of the grade crossing warning system.
- 17 The maximum preemption time is the maximum amount of time needed following initiation of the preemption sequence for the highway traffic signals to complete the timing of the right-of-way transfer time, queue clearance time, and separation time.
- 18 The separation time is the component of maximum preemption time during which the minimum track clearance distance is clear of vehicular traffic prior to the arrival of rail traffic.
- 19 Simultaneous preemption is the notification of approaching rail traffic that is forwarded to the highway traffic signal controller unit or assembly and grade crossing warning system at the same time.
- 20 The right-of-way transfer time is the amount of time needed prior to display of the track clearance interval. This includes any time needed by the railroad, light rail transit, or highway traffic signal control equipment to react to a preemption call, and any traffic control signal green, pedestrian walk and clearance if used (see Section 4F.19), yellow change, and red clearance intervals for conflicting traffic.
- 21 A supervised preemption interconnection is one that incorporates both a normally-open and a normally-closed circuit from the grade crossing warning system to verify the proper operation of the interconnection.

Option:

- 22 Instead of supervision, a double-break preemption interconnection circuit that uses two normally-closed circuits that open both the source and return energy circuits may be used.
- 23 A preemption interconnection may incorporate both supervision and double-break circuits.

Guidance:

- 24 Where train detection circuits are present at a passive grade crossing, the operation of the preemption interconnection should be treated as if active traffic control devices exist at the crossing and the preemption operation should be determined by a Diagnostic Team.
- 25 Where left turns are permitted at a downstream highway-highway traffic control signal from the roadway approach that crosses the track and a delayed or impeded left-turn movement could prevent vehicles from clearing the track, a protected left-turn movement should be provided during the track clearance interval if green signal indications are displayed to the approach for track clearance.
- 26 The decision to implement simultaneous or advance preemption should include consideration of the right-of-way transfer time, the queue clearance time, and the separation time in order to determine the maximum preemption time. These time periods should be compared to and verified with the operation of the grade

crossing traffic control devices in order to evaluate the operation of the highway traffic signal and the preemption operation. These factors should be considered regardless of whether simultaneous or advance preemption operation is implemented as they are based on traffic signal minimum timing, vehicle acceleration characteristics, and physical distances along the roadway.

Support:

- 27 Preemption time variability occurs when the traffic signal controller enters the preemption clearance interval with less than the maximum design right-of-way transfer time or when the speed of a train approaching the grade crossing varies.
- 28 The time interval between the initiation of advance preemption and the operation of the grade crossing warning system for rail traffic will decrease in situations when rail traffic is accelerating or increase in situations when rail traffic is decelerating.

Guidance:

- 29 *Where preemption is used and automatic gates are present, the possibility that an automatic gate might descend upon a vehicle should be analyzed.*
- 30 *If simultaneous preemption is used, an analysis of extended grade crossing warning time requirements should be conducted.*
- 31 *If advance preemption is used, an analysis of preemption operation, traffic signal sequencing, and traffic signal phasing should be conducted to identify preemption time variability. The analysis should include both the condition requiring the longest amount of time to enter the track clearance interval and the condition requiring the shortest amount of time to enter the track clearance interval.*

Standard:

- 32 **Where automatic gates are present and green signal indications are displayed at the downstream traffic control signal during the track clearance interval, the preemption sequence shall be designed such that the green signal indications are not terminated until the automatic gate(s) that controls access over the grade crossing toward the downstream intersection is fully lowered.**

Support:

- 33 The following are two examples of mutually-exclusive methods to resolve preemption time variability:
- A. Gate-down circuitry provides a means to hold the traffic signal controller sequence in the track clearance interval until the automatic gate(s) that controls access over the grade crossing toward the downstream intersection is fully lowered.
 - B. Timing correction resolves preemption time variability by adding the right-of-way transfer time to the track clearance interval in the traffic signal controller unit and setting a fixed maximum period of time between the start of advance preemption and the operation of the flashing-light signals.
- 34 The Third Edition of the “Railroad-Highway Grade Crossing Handbook” and the “2023 AREMA Communications and Signals Manual” published by the American Railway Engineering and Maintenance-of-Way Association (AREMA) provide additional information about preemption time variability.

Standard:

- 35 **Where gate-down circuitry is used to resolve preemption time variability and an automatic gate is broken or is not fully lowered, the crossing control circuits shall not terminate the track clearance interval before the rail traffic has entered the grade crossing.**
- 36 **Where timing correction is used to resolve preemption time variability, a timing circuit shall be used to maintain a maximum time interval between the initiation of advance preemption and the operation of the grade crossing warning system when the approaching rail traffic is decelerating.**

Guidance:

- 37 *Where a highway-highway intersection controlled by traffic control signals is interconnected with a grade crossing equipped with exit gates, advance preemption should be used because of the additional operating time that is required for the exit gates.*
- 38 *Where rail traffic routinely stops and re-starts within or just outside of the approaches to a grade crossing that is interconnected with highway traffic signals, the effects of rail traffic operations on the preemption operation should be analyzed.*
- 39 *Highway traffic signal control equipment should be capable of providing immediate re-service of successive requests for preemption from the railroad warning devices, even if the initial preemption sequence has not been completed. As appropriate, the highway traffic signal control equipment should be able to promptly return to the start of the track clearance interval at any time that the demand for preemption is cancelled and then*

reactivated. The highway traffic signal control equipment should have the ability to provide this immediate re-service at any point in the preemption sequence.

Standard:

- 40 **Where traffic control signals are programmed to operate in a flashing mode during the preemption dwell interval (the period following the track clearance interval that lasts for the duration of the preemption interconnection activation), the beginning of the preemption dwell flashing mode shall not occur until the grade crossing equipment indicates that the rail traffic has entered the grade crossing.**
- 41 **At locations where conflicting preemption calls might be received to serve boats and trains, the Diagnostic Team shall determine the relative priority when conflicting preemption calls occur (see Section 4F.19). Where the boat and the train do not conflict with each other, the Diagnostic Team shall determine the preemption sequence when both preemption calls are occurring simultaneously. The United States Coast Guard or other appropriate authority that regulates the operation of the waterway shall be invited to participate on the Diagnostic Team and/or to provide input to the Diagnostic Team.**

Support:

- 42 Section 4C.10 describes the Intersection Near a Grade Crossing signal warrant that is intended for use at a location where the proximity to the intersection of a grade crossing on an intersection approach controlled by a STOP or YIELD sign is the principal reason to consider installing a traffic control signal.
- 43 Section 4F.19 describes additional considerations regarding preemption of traffic control signals at or near grade crossings.

Section 8D.10 Movements Prohibited During Preemption

Guidance:

- 01 *At a signalized intersection that is located within 100 feet of a grade crossing and the intersection traffic control signals are preempted by the approach of rail traffic, all existing permissive-only turning movements toward the grade crossing should be prohibited, steady red arrow signal indications should be shown to all existing protected/permissive and protected-only turning movements toward the grade crossing, and red signal indications should be shown to the straight-through movement toward the grade crossing during the signal preemption sequences. The prohibition of a permissive-only turning movement toward the grade crossing during preemption should be accomplished through the installation of a blank-out turn prohibition (R3-1a or R3-2a) sign (see Figure 8B-1).*

Option:

- 02 All movements toward the track may be prohibited at a signalized intersection that is preempted by the approach of rail traffic, even if the clear storage distance is more than 100 feet.

Support:

- 03 Including the word “TRAIN” as part of the blank-out turn prohibition sign informs road users that the turn prohibition being displayed by the sign is in effect because rail traffic is approaching or occupying a nearby rail grade crossing, and that the turn prohibition will be terminated after the rail traffic has cleared the grade crossing.
- 04 Rail operations can include the use of activated blank-out turn prohibition (R3-1a or R3-2a) signs at unsignalized highway-highway intersections in the vicinity of grade crossings, such as where a semi-exclusive or mixed-use alignment is within or parallel to the roadway where road users are normally permitted to turn across the tracks.

Guidance:

- 05 *An LRT-activated blank-out turn prohibition (R3-1a or R3-2a) sign should be used during preemption where all three of the following conditions are present:*
- A. There is no active warning system for the LRT grade crossing,*
 - B. Vehicles traveling along a parallel roadway would normally be permitted to turn left or right to travel across tracks that are located within 100 feet of the highway-highway intersection or within the median of the intersection, and*
 - C. The drivers turning at the highway-highway intersection are not controlled by a traffic control signal.*

Standard:

- 06 **Blank-out turn prohibition signs that are associated with preemption shall display their message only when a preemption signal is being received from the railroad or LRT equipment or while the automatic gate is activated.**

Support:

07 The provisions contained in Chapter 2L for blank-out signs are applicable to R3-1a and R3-2a signs.

Section 8D.11 Pre-Signals at or Near Grade Crossings

Guidance:

01 *If a grade crossing is located in close proximity to an intersection controlled by a traffic control signal and the clear storage distance is less than the design vehicle length, the use of pre-signals to control traffic approaching the grade crossing in the direction toward the intersection should be considered.*

02 *If a grade crossing equipped with flashing-light signals, but without automatic gates, is located within 200 feet of an intersection controlled by a traffic control signal, a pre-signal should be provided.*

Support:

03 A pre-signal is generally used where the grade crossing is located less than 200 feet from a downstream signalized intersection. Section 8D.12 contains information for grade crossings located 200 feet or more from a downstream signalized intersection.

04 Other measures that could be considered instead of or in addition to a pre-signal to minimize the possibility of vehicles queuing across the grade crossing include providing additional lanes, reducing the cycle length, using split phasing, using protected turn phasing, and/or providing an extended green interval for the approach.

Standard:

05 **Pre-signal faces shall display a steady red signal indication during the track clearance interval of the signal preemption sequence to prohibit additional motor vehicles from entering the minimum track clearance distance (see Section 8A.07).**

06 **Pre-signal faces shall not display green signal indications when the grade crossing flashing-light signals are displaying flashing red indications.**

Guidance:

07 *Consideration should be given to using visibility-limited signal faces (see definition in Section 1C.02) at the intersection for the downstream signal faces that control the approach that is equipped with pre-signals.*

Option:

08 The duration of the extended green interval may be adjusted by vehicle detection located between the pre-signal and the downstream signalized intersection.

09 The pre-signal phase sequencing may be timed with an offset from the downstream signalized intersection such that the pre-signal's green signal indication terminates prior to the downstream intersection's green signal indication to minimize the possibility of stopping motor vehicles within the minimum track clearance distance (see Section 8A.07) and the clear storage distance .

Guidance:

10 *If pre-signals are used, the queue clearance time (see Section 8D.09) should be long enough to allow a design vehicle of maximum length stopped just inside the minimum track clearance distance (see Section 8A.07) to start up and move through the downstream intersection, or to clear the minimum track clearance distance if there is sufficient clear storage distance.*

Support:

11 The storage area for mandatory left-turn and right-turn lanes at signalized intersections that are downstream from grade crossings sometimes extends from the signalized intersection back to and across the grade crossing. In such cases, drivers that are in the turn lane are required to make a straight-through movement when they cross the track(s) and then are required to make a turning movement when they reach the downstream signalized intersection.

Guidance:

12 *A separate pre-signal face for the mandatory left-turn lane and/or right-turn lane should be provided in addition to the pre-signal signal faces provided for the through movement where both of the following conditions are met:*

A. *The storage area for the turn lane extends from the downstream signalized intersection back to and across the grade crossing, and*

B. *The green interval for the turning movement at the downstream intersection does not always begin and end simultaneously with the green interval for the adjacent through movement at the downstream intersection.*

Standard:

- 13 **Where adjacent lanes at a pre-signal are controlled separately, all of the signal faces shall be capable of displaying the following signal indications: CIRCULAR RED, CIRCULAR YELLOW, and straight-through GREEN ARROW. Left-turn GREEN ARROW and right-turn GREEN ARROW signal indications shall not be used in pre-signal faces. CIRCULAR GREEN signal indications shall not be used in pre-signal faces where adjacent lanes are controlled separately.**

Option:

- 14 Where all adjacent lanes at a pre-signal are controlled together, CIRCULAR GREEN signal indications may be used in pre-signal faces.

Standard:

- 15 **If a separate signal face is provided at a pre-signal for separate control of a mandatory left-turn and/or right-turn lane that extends from the downstream signalized intersection back to and across the grade crossing, the separate signal face shall be devoted exclusively to controlling traffic in the turn lane separately from adjacent lanes, and:**
- A. **Shall be visibility-limited from the adjacent through movement, or**
 - B. **A LEFT (RIGHT) LANE SIGNAL (R10-10b) sign (see Figure 8B-1) shall be mounted adjacent to the separate signal face controlling traffic in a single turn lane or in the turn lane that is farthest from the adjacent through lane(s) if multiple turn lanes are present for a particular turning movement, and a LEFT (RIGHT) TURN LANE SIGNAL (R10-10c) sign (see Figure 8B-1) shall be mounted adjacent to the separate signal face controlling traffic in the other turn lanes if multiple turn lanes are present for a particular turning movement.**

Support:

- 16 Because the signal faces at a pre-signal do not always display the same signal indications as the downstream signalized intersection, the approach to the pre-signal is considered to be a separate approach from the approach to the downstream signalized intersection. This means that the provisions in Sections 4D.05 through 4D.08 regarding the number of signal faces, the visibility and aiming of the signal faces, and the lateral and longitudinal positioning of the signal faces apply separately to the approach to the pre-signal.
- 17 The provisions in Section 4D.07 regarding the lateral positioning of separate turn signal faces are applicable to the separate signal faces that are provided at pre-signals for a mandatory turn lane that extends from the downstream signalized intersection back to and across the grade crossing.

Guidance:

- 18 *A STOP HERE ON RED (R10-6 or R10-6a) sign should be installed at the pre-signal's stop line.*

Standard:

- 19 **If a pre-signal is installed upstream from a signalized intersection, a No Turn on Red (R10-11, R10-11a, or R10-11b) sign (see Section 2B.60) shall be installed at the pre-signal for the approach that crosses the track if turns on red would otherwise be permitted at the downstream intersection.**

Option:

- 20 DO NOT STOP ON TRACKS (R8-8) signs may be installed in conjunction with a pre-signal.
- 21 Pre-signal faces may be located either upstream or downstream from the grade crossing in order to provide the most effective display to road users approaching the grade crossing.
- 22 If pre-signal faces must be located within close proximity to the flashing-light signals, the pre-signal faces may be mounted on the same overhead structure as the flashing-light signals.

Section 8D.12 Queue Cutter Signals at or Near Grade Crossings

Support:

- 01 A queue cutter signal is a traffic control signal that controls one direction of traffic at a grade crossing to minimize the possibility of vehicles stopping within the minimum track clearance distance (see Section 8A.07). Although a queue cutter signal has a similar purpose as a pre-signal (see Section 8D.11), the difference is that a queue cutter signal is independent from the downstream signalized intersection, whereas a pre-signal is part of the downstream signal.

Option:

- 02 At grade crossing locations where the queue from a bottleneck (usually a signalized intersection) that is downstream from the grade crossing frequently extends back to and across the grade crossing, a queue cutter signal may be installed.
- 03 A queue cutter signal may be operated in one of the following modes:
- A. Actuated mode – the queue cutter signal operation is dependent on downstream detection of a growing queue.
 - B. Non-actuated mode – the queue cutter signal operates on a time-of-day plan based on anticipated downstream queues. This mode could be similar to the functional operation of a pre-signal.
 - C. Variable mode – the queue cutter signal operation varies between the actuated mode and the non-actuated mode based on the time of day, on queue detection, or both.

Support:

- 04 A non-actuated queue cutter signal is generally used where the grade crossing is located between 200 feet and 400 feet from a downstream bottleneck. An actuated queue cutter signal is generally used where the grade crossing is located more than 400 feet from a downstream bottleneck. Section 8D.11 contains information for grade crossings located less than 200 feet from a downstream signalized intersection.

Standard:

- 05 **Where adjacent lanes at a queue cutter signal are controlled separately, all of the signal faces shall be capable of displaying the following signal indications: CIRCULAR RED, CIRCULAR YELLOW, and straight-through GREEN ARROW. Left-turn GREEN ARROW and right-turn GREEN ARROW signal indications shall not be used in queue cutter signal faces. CIRCULAR GREEN signal indications shall not be used in queue cutter signal faces where adjacent lanes are controlled separately.**

Option:

- 06 Where all adjacent lanes at a pre-signal are controlled together, CIRCULAR GREEN signal indications may be used in queue cutter signal faces.
- 07 Queue cutter signal faces may be located either upstream or downstream from the grade crossing in order to provide the most effective display to road users approaching the grade crossing.
- 08 If queue cutter signal faces must be located within close proximity to the flashing-light signals, the queue cutter signal faces may be mounted on the same overhead structure as the flashing-light signals.

Guidance:

- 09 *A STOP HERE ON RED (R10-6 or R10-6a) sign should be installed at the queue cutter signal's stop line.*

Option:

- 10 DO NOT STOP ON TRACKS (R8-8) signs may be installed in conjunction with a queue cutter signal.

Guidance:

- 11 *Where a queue cutter signal operates in an actuated mode based on vehicle presence detection, the queue detector should be located to provide adequate distance to detect a growing queue, permit the queue cutter signal to complete any programmed minimum green or yellow change interval time, and then allow a design vehicle that lawfully crosses the queue cutter signal's stop line during the yellow change interval to clear the minimum track clearance distance (see Section 8A.07) before the growing queue extends to the grade crossing.*
- 12 *A queue cutter signal that is operating in an actuated mode and that is displaying CIRCULAR RED signal indications should continue to display CIRCULAR RED signal indications as long as the downstream detection system continues to detect the presence of a vehicular queue at the detection point on the departure side of the grade crossing.*
- 13 *Where a queue cutter signal operates in actuated mode based on vehicle presence detection, consideration should be given to the potential for turning movements between the grade crossing and the downstream bottleneck that could create an intermediate queue of vehicles. Supplemental queue detectors should be considered to detect the formation of these intermediate queues to activate the queue cutter signal.*
- 14 *Where a queue cutter signal is operated in a non-actuated mode, the queue cutter signal should be coordinated with adjacent signals to provide for the progressive movement of traffic.*

Option:

- 15 Where a queue cutter signal is always operated in a non-actuated mode based on anticipated queues, the queue cutter signal may be operated in a flashing mode at times when the downstream queues are not expected to extend back to and across the grade crossing.

16 When a variable-mode queue cutter signal is operating in the non-actuated mode, the queue detector may be used to extend the display of the CIRCULAR RED signal indication as long as the downstream detection system continues to detect the presence of a vehicular queue at the detection point on the departure side of the grade crossing.

Standard:

17 **A queue cutter signal shall be interconnected with the flashing-light signals at the grade crossing.**

18 **Queue cutter signal faces shall not display green signal indications when the grade crossing flashing-light signals are displaying flashing red indications.**

19 **When a queue cutter signal that is displaying straight-through GREEN ARROW signal indications (when operating in a steady, stop-and-go mode) or flashing CIRCULAR YELLOW signal indications (when operating in a programmed flashing mode) is preempted by the approach of rail traffic, it shall immediately display steady CIRCULAR YELLOW signal indications during the yellow change interval (see Section 4F.17) followed by steady CIRCULAR RED signal indications. The queue cutter signal shall continue to display the steady CIRCULAR RED signal indications until the rail traffic clears the grade crossing and no other rail traffic is detected.**

20 **A queue cutter signal operating in an actuated mode shall display straight-through GREEN ARROW signal indications except when it receives an actuation from the downstream vehicle presence detection system or is preempted by the approach of rail traffic. When it receives an actuation from the vehicle presence detection system, the queue cutter signal shall finish timing any active minimum green interval, if used, and then display steady CIRCULAR YELLOW signal indications during the yellow change interval (see Section 4F.17) followed by steady CIRCULAR RED signal indications. When no preemption call is present and the queue length is such that no vehicles are detected in the detection zone of the downstream vehicle presence detection system, the queue cutter signal shall finish timing any active minimum red interval, if used, and then return to the display of straight-through GREEN ARROW signal indications.**

21 **The failure modes of the queue cutter signal control system and vehicle presence detection circuitry shall be evaluated and accounted for in the design of any such system. Fail-safe design techniques shall be used in the system design. If a queue detector fails, the queue cutter signal shall display flashing CIRCULAR RED signal indications until the normal functioning of the detection system is restored.**

Support:

22 The storage area for mandatory left-turn and right-turn lanes at signalized intersections that are downstream from grade crossings sometimes extends from the signalized intersection back to and across the grade crossing. In such cases, drivers that are in the turn lane are required to make a straight-through movement when they cross the track(s) and then are required to make a turning movement when they reach the downstream signalized intersection.

Guidance:

23 *A separate queue cutter signal face for the mandatory left-turn lane and/or right-turn lane should be provided in addition to the queue cutter signal faces provided for the through movement where both of the following conditions are met:*

- A. *The storage area for the turn lane extends from the downstream signalized intersection back to and across the grade crossing, and*
- B. *The green interval for the turning movement at the downstream intersection does not always begin and end simultaneously with the green interval for the adjacent through movement at the downstream intersection.*

Standard:

24 **If a separate signal face is provided at a queue cutter signal for separate control of a mandatory left-turn and/or right-turn lane that extends from the downstream signalized intersection back to and across the grade crossing, the separate signal face shall be devoted exclusively to controlling traffic in the turn lane separately from adjacent lanes, and:**

- A. **Shall be visibility-limited from the adjacent through movement, or**
- B. **A LEFT (RIGHT) LANE SIGNAL (R10-10b) sign (see Figure 8B-1) shall be mounted adjacent to the separate signal face controlling traffic in a single turn lane or in the turn lane that is farthest from the adjacent through lane(s) if multiple turn lanes are present for a particular turning movement, and a LEFT (RIGHT) TURN LANE SIGNAL (R10-10c) sign (see Figure 8B-1) shall be mounted adjacent to the separate signal face controlling traffic in the other turn lanes if multiple turn lanes are present for a particular turning movement.**

Support:

- 25 Because the signal faces at a queue cutter signal do not always display the same signal indications as the downstream signalized intersection, the approach to the queue cutter signal is considered to be a separate approach from the approach to the downstream signalized intersection. This means that the provisions in Sections 4D.05 through 4D.08 regarding the number of signal faces, the visibility and aiming of the signal faces, and the lateral and longitudinal positioning of the signal faces apply separately to the approach to the queue cutter signal.
- 26 The provisions in Section 4D.07 regarding the lateral positioning of separate turn signal faces are applicable to the separate signal faces that are provided at queue cutter signals for a turn lane that extends from the downstream signalized intersection back to and across the grade crossing.
- 27 While queue cutter signals and queue jumping signals have similar names, their purpose, design, and operation are quite different. Care must be taken to avoid confusion between queue cutter signals used in conjunction with a grade crossing and queue jumping signals used with transit operations.

Section 8D.13 Warning Beacons or LED-Enhanced Warning Signs at Grade Crossings**Option:**

- 01 Warning Beacons (see Section 4S.03) or LEDs within the legend, symbol, or border of the sign (see Section 2A.12) may be used to supplement warning signs installed at or on an approach to a grade crossing if additional emphasis is desired for the warning sign. The Warning Beacon or LED-enhanced sign may operate continuously or be activated upon the approach or presence of rail traffic.

Support:

- 02 Most of the warning signs that are used at or on an approach to a grade crossing warn of physical conditions that exist at the grade crossing regardless of whether rail traffic is approaching or occupying the grade crossing. In these cases, a Warning Beacon or LED-enhanced sign would typically be operated continuously to enhance the conspicuity of the sign.
- 03 Some warning signs, such as a BE PREPARED TO STOP (W3-4) sign (see Section 2C.35), if used in advance of a grade crossing and supplemented with a WHEN FLASHING (W16-13P) plaque, provide information that is typically not applicable except when rail traffic is approaching or occupying the grade crossing. Likewise, a special word message sign (see Section 2A.04) with a legend such as TRAIN WHEN FLASHING provides notice of a condition that only exists when rail traffic is approaching or occupying the grade crossing. These signs would not typically be operated continuously, but instead only when the condition is present.

Standard:

- 04 **If a Warning Beacon or LEDs within the legend, symbol, or border of the sign is activated by the approach or presence of rail traffic in conjunction with a warning sign that includes the legend WHEN FLASHING either on the sign itself or on a supplemental plaque, the activation of the Warning Beacon or LEDs shall be accomplished by a supervised preemption interconnection using fail-safe design principles (see Section 8D.09) between the control circuits of the grade crossing warning system and the Warning Beacon or LED-enhanced sign.**

Support:

- 05 In the event of a system failure, the normal fault state using a fail-safe interconnection for a Warning Beacon or LED-enhanced sign that is activated by the approach or presence of rail traffic at the grade crossing would be for the Warning Beacon or LEDs to operate when no rail traffic is present.

Option:

- 06 A Warning Beacon or LED-enhanced sign that is activated by the approach or presence of rail traffic at the grade crossing may continue to operate for a period of time following the passage of the rail traffic to permit the standing queue to dissipate.

Guidance:

- 07 *If a Warning Beacon or LED-enhanced sign is activated by the approach or presence of rail traffic at the grade crossing, the Warning Beacon or LED-enhanced sign should begin operating prior to the activation of the flashing-light signals at the grade crossing based upon the typical travel time from the location of the Warning Beacon or LED-enhanced sign to the stop line for the grade crossing.*
- 08 *If a Warning Beacon or LED-enhanced sign that is activated by the approach or presence of rail traffic at the grade crossing is operated by commercial AC power, a back-up power system should be provided.*

Section 8D.14 Traffic Control Signals at or Near Highway-LRT Grade Crossings

Support:

- 01 There are two types of traffic control signals for controlling vehicular and LRT movements at interfaces of the two modes. The first is the standard traffic control signal described in Part 4, which is the focus of this Section. The other type of signal is referred to as an LRT signal and is discussed in Section 8D.15.

Standard:

- 02 **The provisions of Part 4 and Sections 8D.08 through 8D.12 relating to traffic control signal design, installation, and operation, including interconnection with nearby automatic gates or flashing-light signals, shall be applicable as appropriate where traffic control signals are used at highway-LRT grade crossings.**
- 03 **If traffic control signals are in operation at an LRT grade crossing that is used by pedestrians, bicyclists, and/or other non-motorized road users, an audible device such as a bell shall also be provided and shall be operated in conjunction with the traffic control signals.**

Guidance:

- 04 *If the highway traffic signal has emergency-vehicle preemption capability, it should be coordinated with LRT operation.*
- 05 *Where LRT operates in a wide median, motor vehicles crossing the tracks and being controlled by both near and far side traffic signal faces should receive a protected left-turn phase from the far side signal face to clear motor vehicles from the crossing when LRT traffic is approaching the crossing.*

Option:

- 06 Signal indications that permit the movement of motor vehicles, pedestrians, and bicyclists and do not conflict with LRT movements may be provided during LRT phases.
- 07 A traffic control signal may be installed in addition to Exit Gate systems and automatic gates at a highway-LRT grade crossing if the crossing occurs within a highway-highway intersection and if the installation of the traffic control signal can be justified based on the warrants described in Chapter 4C.
- 08 Where a highway-LRT grade crossing is at a location other than an intersection and LRT operating speeds are less than 25 mph, traffic control signals may be used in lieu of flashing-light signals.

Support:

- 09 Typical circumstances for using traffic control signals might include:
- A. Geometric conditions preclude the installation of highway-LRT grade crossing warning devices,
 - B. LRT vehicles share the same roadway with road users, or
 - C. Traffic control signals already exist.
- 10 Section 4F.18 contains information regarding traffic control signals at or near highway-LRT grade crossings that are not equipped with highway-LRT grade crossing warning devices.
- 11 Section 4C.10 describes the Intersection Near a Grade Crossing signal warrant that is intended for use at a location where the proximity to the intersection of a grade crossing on an intersection approach controlled by a STOP or YIELD sign is the principal reason to consider installing a traffic control signal.

Guidance:

- 12 *When a highway-LRT grade crossing exists within a signalized intersection, consideration should be given to providing separate turn signal faces (see definition in Section 1C.02) for the movements crossing the tracks.*

Standard:

- 13 **Separate turn signal faces that are provided for turn movements toward the crossing shall display a steady red indication during the approach and/or passage of LRT traffic.**

Support:

- 14 Section 8D.10 contains information regarding the prohibition of turning movements toward the crossing during preemption.

Section 8D.15 Use of LRT Signals for Control of LRT Vehicles at Highway-LRT Grade Crossings

Option:

- 01 LRT signal indications may be used at grade crossings and at intersections in mixed-use alignments in conjunction with standard traffic control signals where special LRT signal phases are used to accommodate turning LRT vehicles or where additional LRT clearance time is desirable.
- 02 LRT signal indications may be used at intersections where special signal phases are used for bus movements.

Standard:

- 03 **If the LRT crossing control is separate from the intersection control, the two shall be interconnected. The LRT signal phase shall not be terminated until after the LRT vehicle has cleared the crossing or intersection.**
- 04 **If a separate set of standard traffic control signal indications (red, yellow, and green circular and arrow indications) is used to control LRT movements, the indications shall be positioned so they are not visible to motorists, pedestrians, and bicyclists (see Section 4D.06).**

Guidance:

- 05 *If a signal face used to control LRT movements cannot be positioned where the indications are not visible to road users, the LRT signal indications shown in Figure 8D-3 should be used.*

Standard:

- 06 **If special LRT signal indications such as those shown in Figure 8D-3 are used, the color of the signal indications shall be white.**

Option:

- 07 *If used, individual LRT signal sections may be displayed to form clustered signal faces or multiple LRT signal indications may be displayed in an individual housing.*

Guidance:

- 08 *LRT signal faces should be located at least 3 feet from the nearest highway traffic signal face for the same approach measured either horizontally perpendicular to the approach between the centers of the signal faces or vertically from the center of the lowest signal indication of the top signal face to the center of the highest signal indication of the bottom signal face.*

Support:

- 09 Section 4F.18 contains information about the use of the LRT signal indications shown in Figure 8D-3 for the control of exclusive bus movements at “queue jumper lanes” and for the control of exclusive bus rapid transit movements on mixed-use alignments.

Figure 8D-3. Light Rail Transit Signal Indications



Notes:

- 1. All rectangular bar signal indications shall be white.
- 2. Go signal indications may be flashed to inform LRT operators to prepare to stop.

CHAPTER 8E. PATHWAY AND SIDEWALK GRADE CROSSINGS

Section 8E.01 Purpose

Support:

- 01 Traffic control for pathway and sidewalk grade crossings includes all signs, signals, markings, other warning devices, and their supports at pathway and sidewalk grade crossings and along pathway and sidewalk approaches to grade crossings. The function of this traffic control is to promote safety and provide effective operation of both rail and pathway or sidewalk traffic at pathway or sidewalk grade crossings.
- 02 Other physical treatments that are described in this Chapter that are also applicable to pathways and sidewalks at grade crossings, such as detectable warnings, swing gates, and fencing, provide increased safety for pathway and sidewalk users.
- 03 Crosswalk markings at intersections where pedestrians cross LRT tracks in mixed-use alignments are covered by the provisions of Chapter 3C rather than by the provisions of this Chapter.
- 04 Figure 8E-1 illustrates the difference between a pathway grade crossing and a sidewalk grade crossing. A pathway is frequently placed in its own right-of-way on an alignment that is independent of any roadway. If a pathway is built parallel to a roadway, it is physically separated from the roadway by an open space or barrier such that the traffic control devices for the roadway grade crossing do not exert an influence over or provide adequate warning to pathway users. A sidewalk runs parallel to a roadway within the highway right-of-way and is close enough to the edge of the roadway's traveled way that the traffic control devices for the roadway grade crossing can frequently exert an influence over or provide adequate warning to sidewalk users. Pathways are typically used by both pedestrians and bicyclists, whereas sidewalks are typically used only by pedestrians.

Figure 8E-1. Illustration of the Difference between a Pathway Grade Crossing and a Sidewalk Grade Crossing

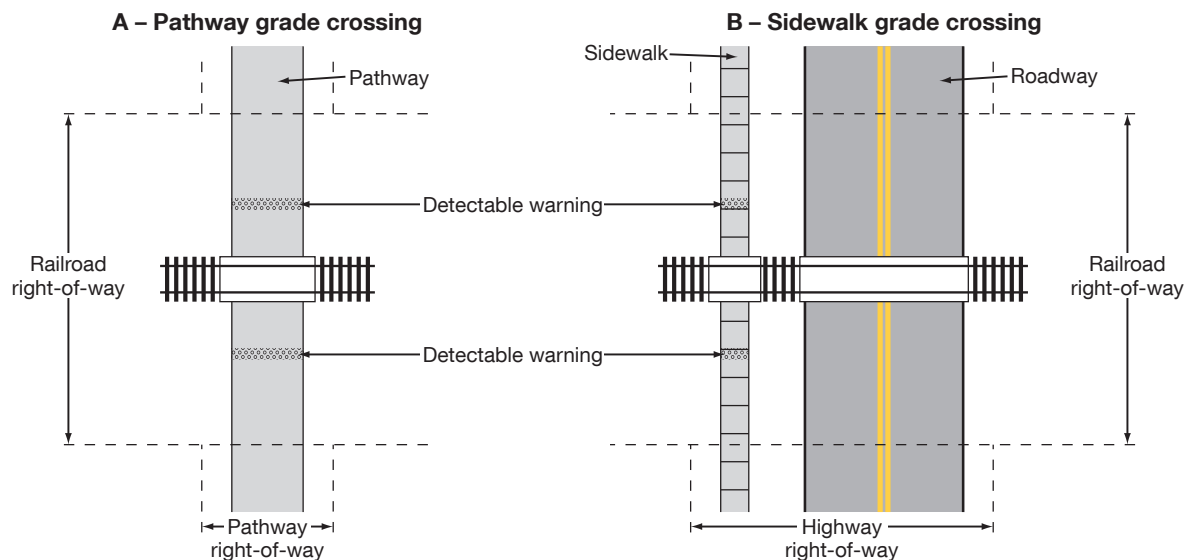

Section 8E.02 Use of Standard Devices, Systems, and Practices

Guidance:

- 01 The pathway or sidewalk user's ability to detect the presence of approaching rail traffic should be considered in determining the type and placement of traffic control devices at pathway or sidewalk grade crossings.
- 02 The traffic control devices, including the appropriate traffic control system to be used, and other physical treatments at a pathway or sidewalk grade crossing should be determined by a Diagnostic Team that includes the agency with jurisdiction over the pathway or sidewalk.
- 03 At skewed grade crossings, the adjustment, re-alignment, or relocation of existing sidewalk grade crossings should be considered when determining the placement of traffic control devices for roadway users.

Support:

04 The safety of pathway and sidewalk users is enhanced when pathways and sidewalks are designed such that they do not cross the tracks at a narrow angle. The casters of wheelchairs and the wheels of bicycles could fall into and might be constrained in the flangeway gap at a skewed crossing. The flangeway gap is typically 2.5 inches wide at LRT grade crossings and 3 inches wide at railroad grade crossings.

05 It is desirable that pathways and sidewalks be designed such that they maintain a relatively consistent horizontal alignment and profile from the nearest rail to the detectable warning (if present) or from the nearest rail to the stop line (if present) on each approach to the crossing. Providing a pedestrian refuge area in advance of the stop line or the detectable warning surface so that pedestrians have a place to wait while rail traffic approaches and occupies the crossing can be beneficial to pedestrian safety.

06 When designing new sidewalk grade crossings, placing the sidewalk outside of the area occupied by grade crossing traffic control devices for vehicular traffic is desirable (see Figure 8E-2). This includes making sure that the counterweights and support arms for the automatic gates for vehicular traffic do not obstruct the sidewalk when the gate is fully lowered.

07 Additional information regarding the design of pathways and sidewalks is contained in the U.S. Department of Justice 2010 ADA Standards for Accessible Design, September 15, 2010, 28 CFR 35 and 36, Americans with Disabilities Act of 1990.

Section 8E.03 Pathway and Sidewalk Grade Crossing Signs and Markings

Standard:

- 01 **Pathway and sidewalk grade crossing signs shall be standard in shape, legend, and color.**
- 02 **The minimum sizes of sidewalk grade crossing signs that are intended to be viewed only by sidewalk users and of pathway grade crossing signs shall be as shown in the shared-use path column in Table 9A-1.**

Guidance:

- 03 *No portion of a traffic control device or its support should protrude into the pathway or sidewalk grade crossing. Sidewalk and pathway grade crossing traffic control devices should be located such that all physical features of the device, including the support hardware, conform to clearance requirements provided by the railroad company and/or transit agency, and the regulatory agency with statutory authority (if applicable).*
- 04 *The minimum mounting height for post-mounted signs adjacent to pathways and sidewalks should be 4 feet, measured vertically from the bottom of the sign to the elevation of the near edge of the pathway or sidewalk surface (see Figure 9A-1).*
- 05 *If overhead traffic control devices are placed above pathways, the clearance from the bottom of the device to the pathway surface directly under the sign or device should be at least 8 feet.*
- 06 *If overhead traffic control devices are placed above pathways that are used by equestrians, the clearance from the bottom of the device to the pathway surface directly under the sign or device should be at least 10 feet.*

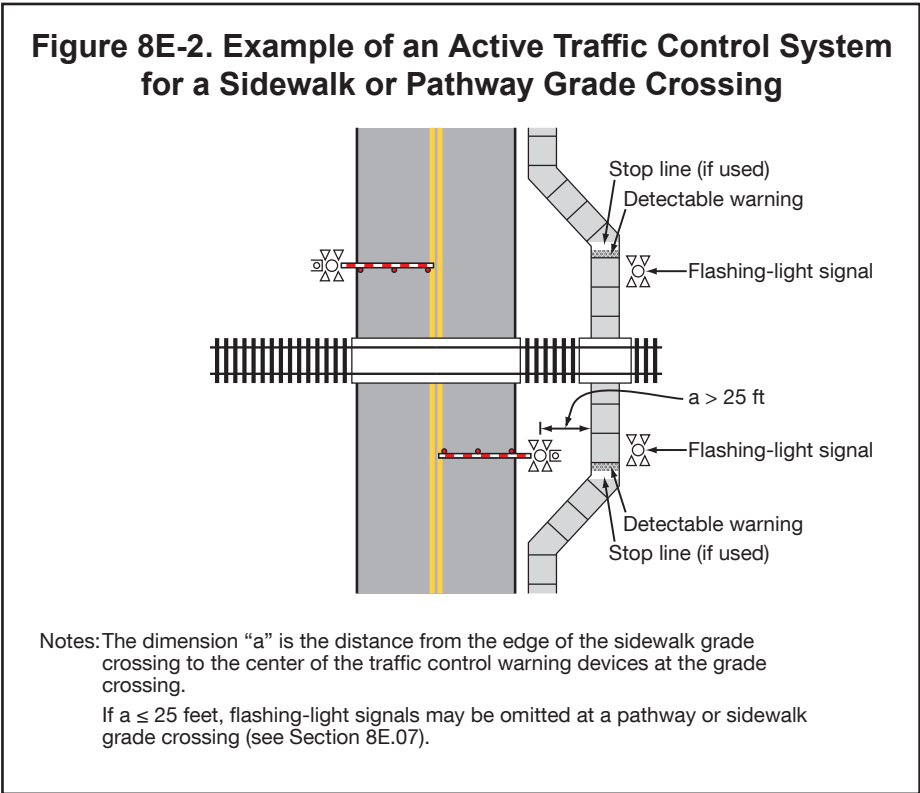

Standard:

- 07 If overhead traffic control devices are placed above sidewalks, the clearance from the bottom of the device to the sidewalk surface directly under the sign or device shall be at least 7 feet.

Guidance:

- 08 Traffic control devices mounted adjacent to pathways at a height of less than 8 feet measured vertically from the bottom of the device to the elevation of the near edge of the pathway surface should have a minimum lateral offset of 2 feet from the near edge of the device to the near edge of the pathway (see Figure 9A-1).
- 09 If pathway users include those who travel faster than pedestrians, such as bicyclists or skaters, warning signs should be installed in advance of the pathway grade crossing (see Figure 8E-3).

Option:

- 10 The Skewed Crossing (W10-12) sign (see Section 8B.22) may be used at a skewed pathway or sidewalk grade crossing to warn pathway or sidewalk users that the tracks are not perpendicular to the pathway or sidewalk.
- 11 The LOOK (R15-8) sign (see Figure 8B-1) may be used at a pathway or sidewalk grade crossing to inform pathway or sidewalk users to look in both directions prior to crossing the track(s).

Guidance:

- 12 If a LOOK (R15-8) sign is used at a pathway or sidewalk grade crossing, it should be mounted on a separate post that is farther from the pathway or sidewalk than the Crossbuck sign or Crossbuck Assembly.

Figure 8E-3. Example of Signing and Markings at a Pathway Grade Crossing

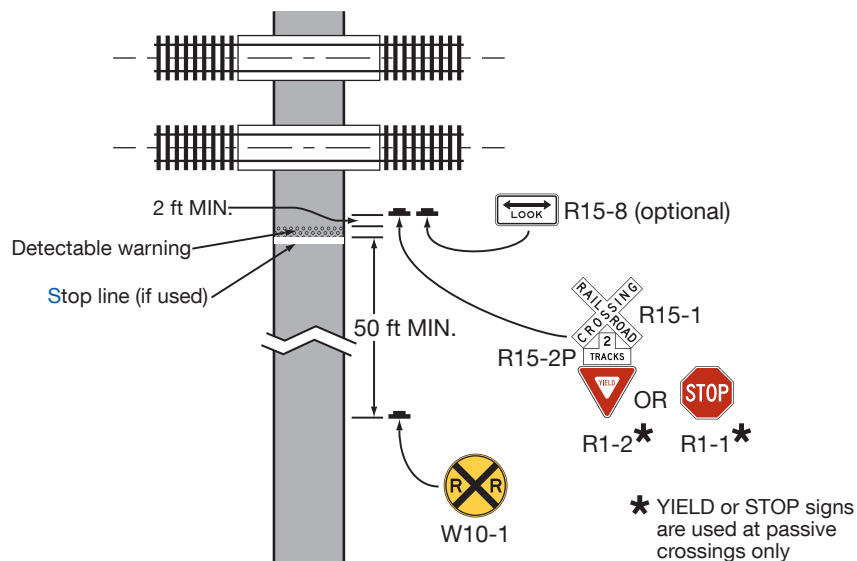

Section 8E.04 Stop Lines, Edge Lines, and Detectable Warnings

Guidance:

- 01 A stop line should be provided at a pathway grade crossing if the surface where the marking is to be applied is capable of retaining the application of the marking.

Option:

- 02 A stop line may be provided at a sidewalk grade crossing if the surface where the marking is to be applied is capable of retaining the application of the marking.

Guidance:

- 03 If used at pathway or sidewalk grade crossings, the stop line should be a transverse line that extends across the full width of the pathway or sidewalk at the point where a pathway or sidewalk user is to stop. If no detectable warning is provided, the stop line should be placed at least 2 feet in advance of the automatic gate, counterweight, flashing-light signals, or Crossbuck Assembly (if any of these are present), and at least 12 feet from the nearest rail.

Option:

- 04 Edge lines (see Section 3B.09) to delineate the designated user route may be used on the approach to and across the tracks at a pathway grade crossing, a sidewalk grade crossing, or a station crossing if the surface where the marking is to be applied is capable of retaining the application of the marking.

Support:

- 05 Edge line delineation can be beneficial where the distance across the tracks is long, commonly because of a skewed grade crossing or because of multiple tracks, or where the pathway or sidewalk surface is immediately adjacent to a traveled way.
- 06 Information regarding the design of detectable warning surfaces is contained in the U.S. Department of Justice 2010 ADA Standards for Accessible Design, September 15, 2010, 28 CFR 35 and 36, Americans with Disabilities Act of 1990.

Standard:

- 07 **Detectable warnings (see Chapter 3C) shall be used at pathway grade crossings where pedestrian travel is permitted and at sidewalk grade crossings and shall extend across the full width of the pathway or sidewalk.**

Guidance:

- 08 *The dimension of the detectable warning in the direction of pedestrian travel should be at least 2 feet.*
- 09 *Detectable warnings should be placed immediately beyond the pathway or sidewalk stop line (if a stop line is present) or should be incorporated into and made a part of the stop line. The downstream edge of the detectable warning should be located at least 2 feet upstream from the automatic gate, counterweight, flashing-light signals, or Crossbuck Assembly (if any of these are present) and at least 12 feet from the nearest rail (see Figures 8E-2 and 8E-3).*
- 10 *If the distance between the nearest rail of two adjacent tracks at a sidewalk or pathway grade crossing is 30 feet or more, additional detectable warnings should be used to designate the limits of the pedestrian refuge area (see Figure 8E-4).*

Option:

- 11 At pathway-LRT and sidewalk-LRT grade crossings, the downstream edge of the detectable warning may be located less than 12 feet from the nearest rail.

Guidance:

- 12 *The downstream edge of the detectable warning at pathway-LRT and sidewalk-LRT grade crossings should be located at least 2 feet upstream from the automatic gate, counterweight, flashing-light signals, or Crossbuck Assembly (if any of these are present), at least 6 feet from the nearest rail, and in accordance with the requirements of the railroad company and/or transit agency, and regulatory agency with statutory authority (if applicable).*

Figure 8E-4. Example of Detectable Warning and Stop Lines for a Refuge Area at a Sidewalk Grade Crossing

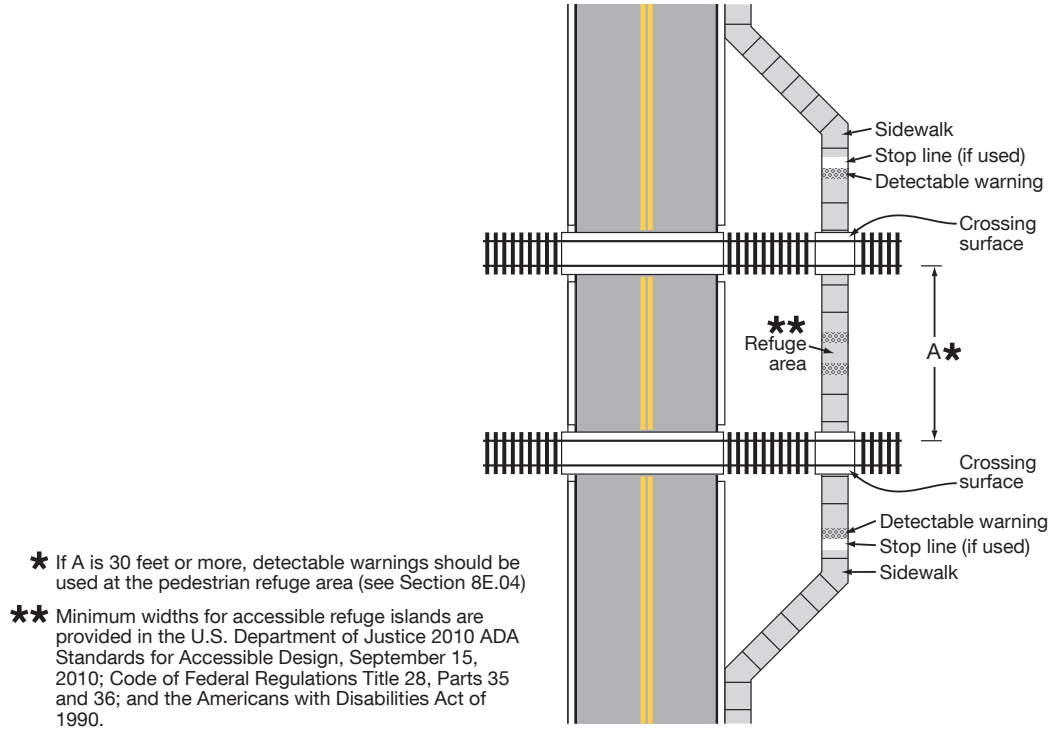

Section 8E.05 Passive Traffic Control Devices – Crossbuck Assemblies

Standard:

01 Where the nearest edge of a passive pathway or sidewalk grade crossing is located more than 25 feet from the center of the nearest traffic control warning device at the grade crossing, a Crossbuck Assembly (see Figure 8E-5) shall be installed on each approach to the pathway or sidewalk grade crossing. The distance shall be measured perpendicular to the traveled way from the center of the support post of a Crossbuck Assembly at a passive grade crossing or from the center of the mast of an active traffic control warning device at an active grade crossing to the nearest edge of the pathway or sidewalk surface where it crosses the track(s) (see Figure 8E-2).

Option:

02 A Crossbuck Assembly may be installed on the approaches to a pathway or sidewalk grade crossing where the nearest edge of the pathway or sidewalk is located 25 feet or less from the center of the nearest traffic control warning device at a grade crossing.

03 The Crossbuck Assembly may be omitted at station crossings.

04 The retroreflective strip on the back of the support may be omitted on the Crossbuck support at a pathway or sidewalk grade crossing.

Standard:

05 The minimum height, measured vertically from the bottom of the YIELD or STOP sign to the elevation of the near edge of the pathway or sidewalk, of Crossbuck Assemblies installed on pathways or sidewalks shall be 4 feet where the lateral offset to the nearest edge of the sign is 2 feet or more and shall be 7 feet where the lateral offset to the nearest edge of the sign is less than 2 feet (see Figure 8E-5).

06 The minimum lateral offset, measured horizontally from the nearest edge of the pathway or sidewalk to the nearest edge of the Crossbuck Assembly signs, shall be 0 feet for sidewalks and 2 feet for pathways.

Section 8E.06 Channelizing Devices Used with Sidewalk and Pathway Traffic Control Devices

Support:

01 The pathway or sidewalk user’s ability to detect the presence of approaching rail traffic needs to be considered in determining the type and placement of channelizing devices such as swing gates, fencing, and pedestrian barriers.

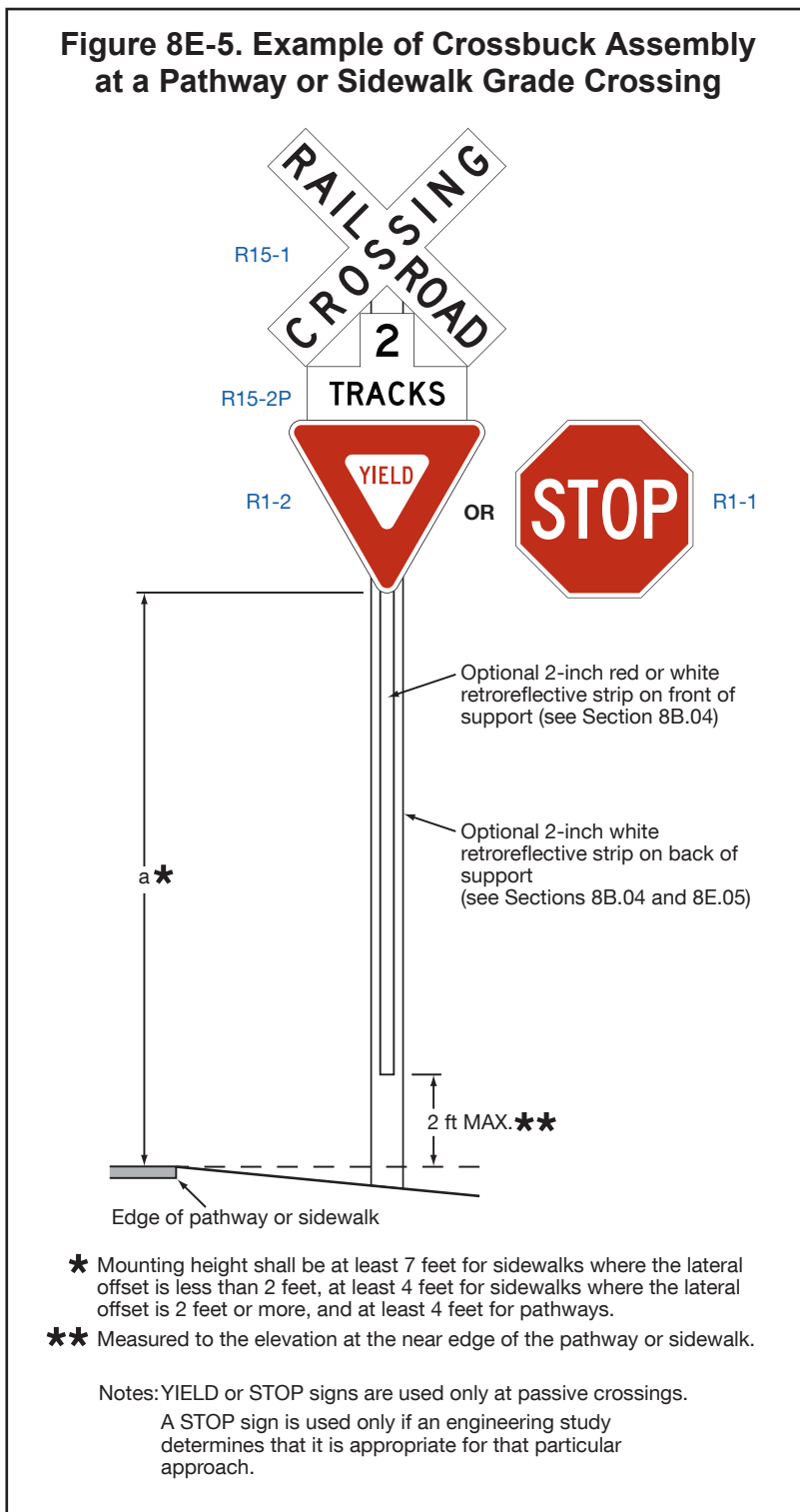

- 02 Where automatic gates and swing gates are used, it is desirable to design the pathway or sidewalk in a manner that channelizes or directs users to the entrance to and exit from the pathway or sidewalk grade crossing.
- 03 Swing gates (see Figures 8E-6, 8E-9, and 8E-10) are designed to open away from the track(s) so that pathway or sidewalk users can quickly push the swing gate open when moving away from the track(s), and to automatically return to the closed position after each use.
- 04 It is important to use retroreflective material, appropriate object markers (see Section 9C.09), and/or signs on swing gates, maze fencing, or pedestrian barriers that are placed at pathway or sidewalk grade crossings. Illumination of such areas can also be beneficial.
- 05 When used in conjunction with automatic gates at a pathway or sidewalk grade crossing, swing gates are typically equipped with a latching device that permits the swing gate to be opened only from the track side of the swing gate. Push bars, kick plates, or similar devices are also appropriate for use on a swing gate.
- 06 Latching devices that are used on swing gates need to be designed in a manner such that they are operable by all users of the pathway or sidewalk.

Guidance:

- 07 A swing gate should be equipped with a *PUSH TO EXIT (I13-2)* sign on the track side of the swing gate, and a *DO NOT ENTER (R5-1)* sign on the side of the swing gate facing away from the tracks (see Figure 8E-10).

Support:

- 08 The U.S. Department of Justice 2010 ADA Standards for Accessible Design, September 15, 2010, 28 CFR 35 and 36, Americans with Disabilities Act of 1990 contains information regarding the design of swing gates and related hardware.

- 09 Where fencing (see Figures Figure 8E-6 and Figure 8E-9) is installed to direct pathway or sidewalk users to the grade crossing, it is desirable that this fencing be connected to any continuous existing or new fencing or channelization that has been installed parallel to the track(s) to discourage pedestrians from circumventing the grade crossing.

- 10 Pedestrian barriers or fencing, sometimes referred to as a “maze fencing,” direct pathway or sidewalk users to face approaching rail traffic before entering the trackway.

- 11 Where used, maze fencing or pedestrian barriers need to be designed to permit the passage of wheelchairs and power-assisted mobility devices, and if bicycles are permitted, to permit the passage of dismounted bicyclists with tandem bicycles, cargo bicycles, or bicycles with trailers.

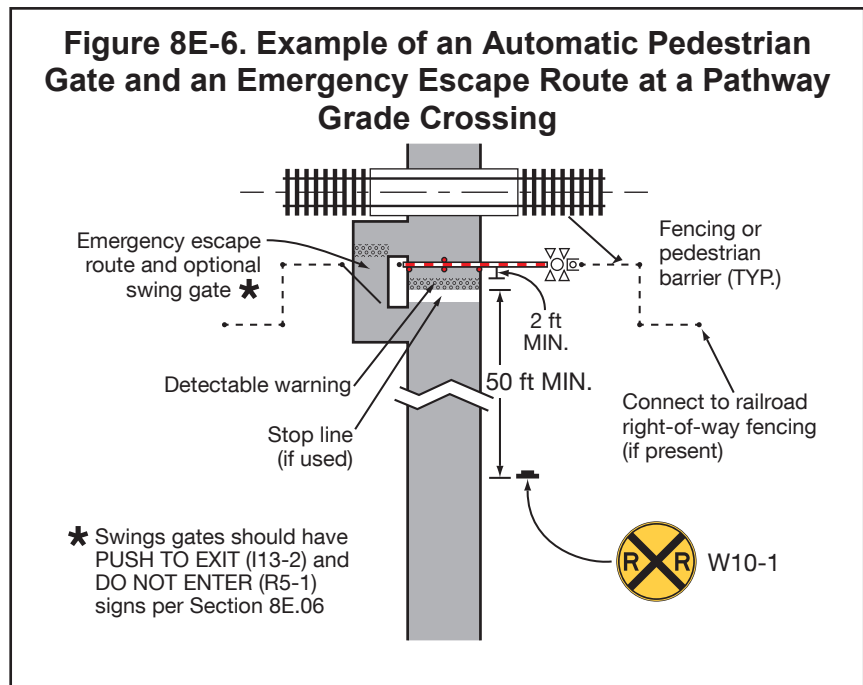

Section 8E.07 Active Traffic Control Systems

Standard:

- 01 Except as provided in Paragraph 5 of this Section, at pathway-LRT and sidewalk-LRT grade crossings where LRT operating speeds on a semi-exclusive alignment exceed 25 mph, active traffic control systems shall be used.
- 02 Except as provided in Paragraph 5 of this Section, at pathway-LRT and sidewalk-LRT grade crossings where LRT operating speeds on a semi-exclusive alignment exceed 40 mph, active traffic control systems, including automatic gates, shall be used.
- 03 If used at a pathway or sidewalk grade crossing, an active traffic control system (see Section 8D.01) shall include flashing-light signals (see Figure 8E-7) on each approach to the crossing.

Guidance:

04 *If used at a pathway or sidewalk grade crossing, an active traffic control system (see Section 8D.01) should include an audible device such as a bell that is operated in conjunction with the flashing-light signals.*

Option:

05 Flashing-light signals, bells, and other audible warning devices may be omitted at pathway or sidewalk grade crossings that are located within 25 feet of an active warning device at a grade crossing that is equipped with those devices.

06 Additional pairs of flashing-light signals, bells, or other audible warning devices may be installed on the active traffic control devices at a grade crossing for pathway or sidewalk users approaching the grade crossing from the back side of those devices.

Guidance:

07 *Where railroad or LRT tracks in a semi-exclusive alignment are parallel and immediately adjacent to a roadway and if adequate space exists, a pedestrian refuge area or island should be provided between the tracks and the roadway to permit pedestrians to stand clear of the tracks while waiting to cross the roadway and to stand clear of the roadway while waiting to cross the tracks. If a pedestrian refuge area or island is provided at a signalized crossing of the roadway, additional pedestrian features (see Chapter 4I), such as signal heads, signing, and detectors, should be installed in the refuge area or on the island.*

Figure 8E-7. Example of a Flashing-Light Signal Assembly at a Pathway or Sidewalk Grade Crossing

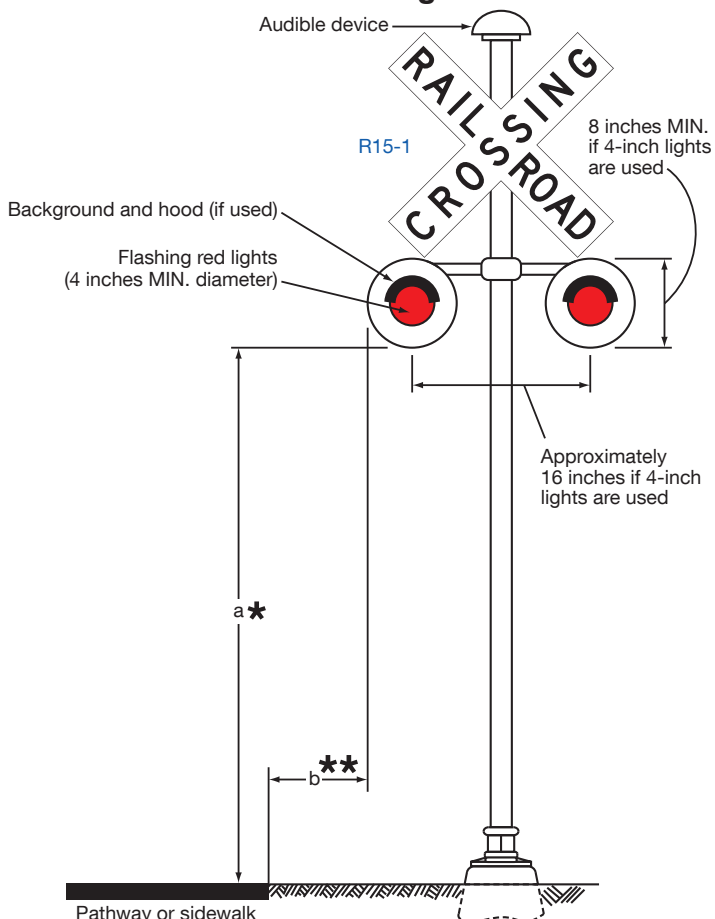

- * Minimum mounting height adjacent to sidewalks and pathways should be 4 feet. Minimum mounting height above a sidewalk shall be 7 feet. Minimum mounting height above a pathway should be 8 feet.
- ** Minimum lateral offset for pathways should be 2 feet. Sidewalks do not have a minimum lateral offset.

Section 8E.08 Active Traffic Control Devices – Signals

Support:

01 Pedestrian signal heads are typically used at highway-highway intersections where pedestrians have an expectation that other roadway users will sometimes be legally required to yield the right-of-way to them. At grade crossings where rail traffic does not stop, pedestrians will not have the right-of-way yielded to them. Therefore, pedestrian signal heads are not an appropriate traffic control device to use at a pathway or sidewalk grade crossing where rail traffic does not stop. Instead, the universal application of horizontally-aligned, alternately-flashing red lights is the uniform active traffic control device for all grade crossings where rail traffic does not stop including pathway and sidewalk grade crossings.

Standard:

02 **Except as provided in Paragraph 3 of this Section, pedestrian signal heads as described in Chapter 4I comprised of Upraised Hand and Walking Person symbols shall not be used at a pathway or sidewalk grade crossing.**

Figure 8E-8. Example of an Automatic Pedestrian Gate at a Pathway or Sidewalk Grade Crossing

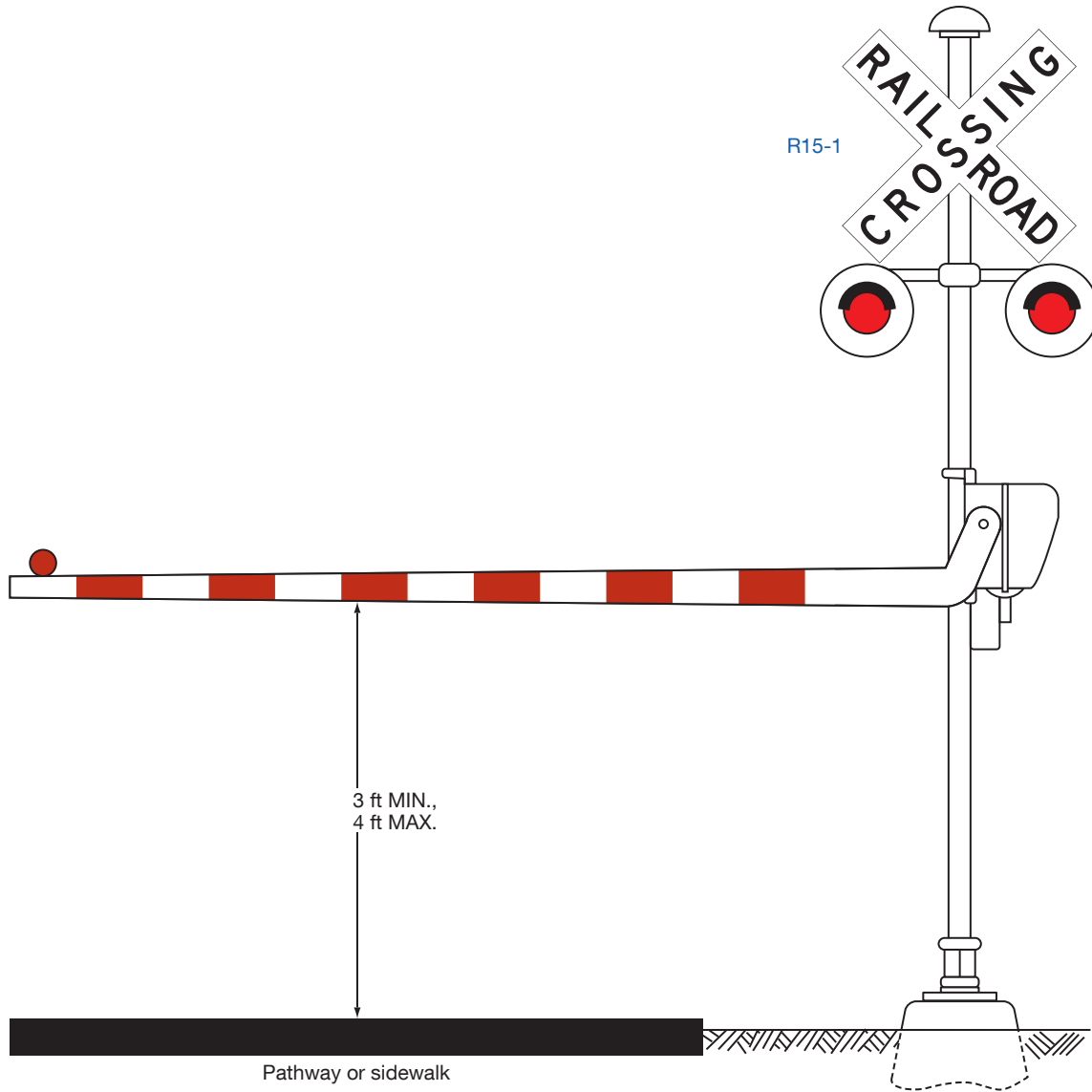

Figure 8E-9. Example of Active Traffic Control Systems with Automatic Pedestrian Gates and Swing Gates at a Sidewalk Grade Crossing

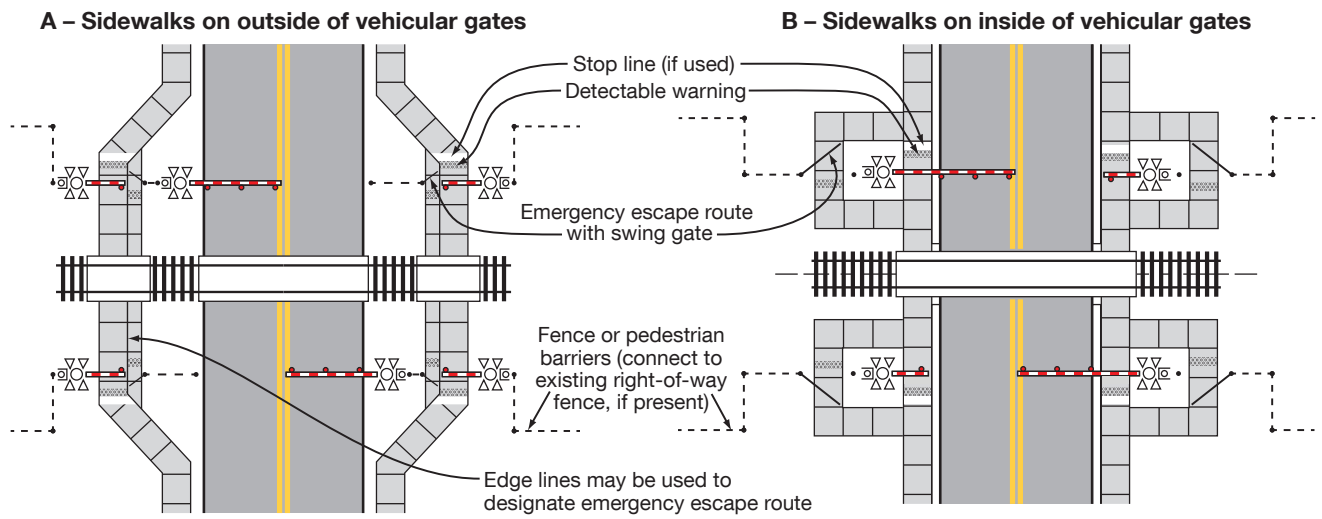
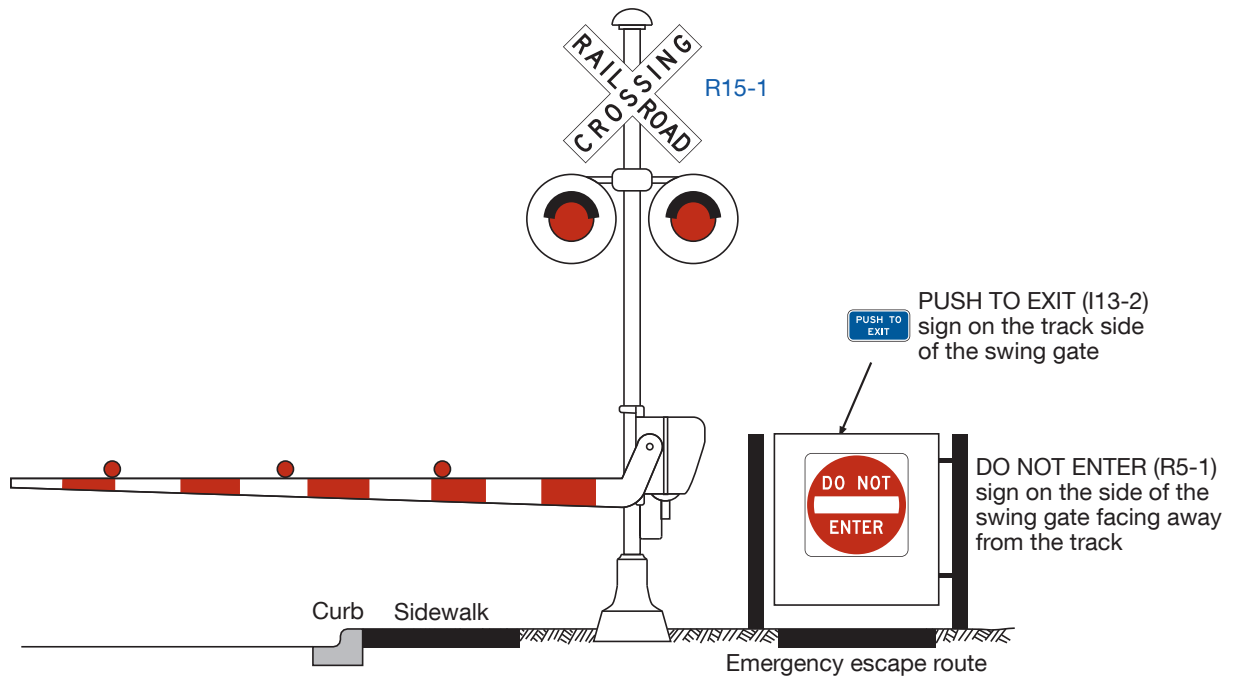

Figure 8E-10. Example of Traffic Control Devices for an Optional Swing Gate



Option:

- 03 Pedestrian signal heads may be used at a pathway or sidewalk grade crossing where the movement of LRT vehicles is controlled by a traffic control signal or by special LRT signals (see Section 8D.15).

Standard:

- 04 If used at a pathway or sidewalk grade crossing, flashing-light signals shall be aligned horizontally and the light units shall have a diameter of at least 4 inches. For 4-inch diameter light units, the light centers shall be spaced approximately 16 inches apart and, if used, the flashing light unit backgrounds shall be at least 8 inches in diameter. (See FHWA Known Errors 01/24/2025)

Figure 8E-11. Example of a Separate Automatic Pedestrian Gate

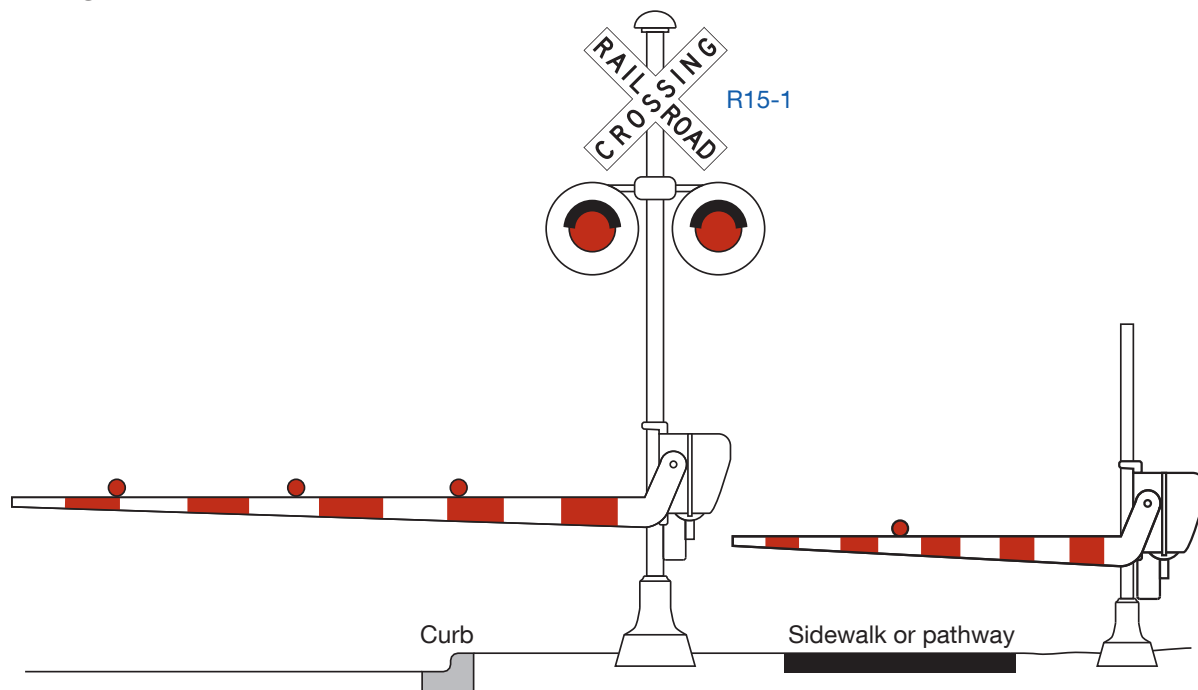

- 05 Each red signal unit in the flashing-light signal shall flash alternately. The number of flashes per minute for each lamp shall be 35 minimum and 65 maximum. Each lamp shall be illuminated for approximately the same length of time. The total time of illumination of each pair of lamps shall be the entire operating time.

- 06 The minimum mounting height of the flashing-light signals shall be 4 feet, measured vertically from the bottom edge of the lights to the elevation of the near edge of the pathway or sidewalk surface.

Option:

- 07 At station, pathway, or sidewalk grade crossings with multiple tracks, traffic control devices may be installed between the tracks in compliance with any railroad clearance requirements.

Standard:

- 08 The mounting height for flashing-light signals that are installed between the tracks at multiple-track crossings shall be a minimum of 1 foot, measured vertically from the bottom edge of the lights to the elevation of the near edge of the pathway surface.

Guidance:

- 09 If a Diagnostic Team finds that a flashing-light signal with a Crossbuck sign and an audible device is still not resulting in appropriate pedestrian behavior, consideration should be given to also installing an automatic pedestrian gate (see Section 8E.09).
- 10 Flashing-light signals (see Figure 8E-7) with a Crossbuck (R15-1) sign and an audible device should be installed along semi-exclusive LRT alignments at station, pathway, or sidewalk grade crossings where the

Diagnostic Team has determined that the sight distance is not sufficient for pathway or sidewalk users to complete their crossing prior to the arrival of LRT traffic at the crossing.

- 11 *If the Diagnostic Team determines that flashing-light signals with a Crossbuck sign and an audible device would not provide sufficient notice of approaching LRT traffic, consideration should be given to also installing an automatic pedestrian gate (see Section 8E.09) with appropriate channelization or fencing.*

Section 8E.09 Active Traffic Control Devices – Automatic Pedestrian Gates

Option:

- 01 Automatic pedestrian gates (see Figures 8E-6, 8E-8, 8E-9, 8E-11, and 8E-12) may be used at pathway or sidewalk grade crossings.

Standard:

- 02 **A pathway or sidewalk grade crossing across tracks where trains are permitted to travel at speeds of 80 mph or higher shall be equipped with a system of automatic pedestrian gates and an escape area with swing gates and fencing installed in the vicinity of the crossing to direct users to the pathway or sidewalk grade crossing (see Figure 8E-6) unless the Diagnostic Team determines that other safety treatments for the crossing would be more appropriate.**

Guidance:

- 03 *Where automatic pedestrian gates are installed across a pathway or sidewalk at a grade crossing, or where a sidewalk is located between the edge of a roadway and the support for an automatic gate arm that extends across the sidewalk and into the roadway, an emergency escape route (see Figures 8E-9 and 8E-10) should be provided to allow pedestrians to egress away from the track area when the automatic pedestrian gates are activated.*

Standard:

- 04 **Except as provided in Paragraph 6 of this Section, automatic pedestrian gate arms shall be provided with at least one red light as shown in Figures 8E-6, 8E-8, 8E-9, 8E-11, and 8E-12. This light shall be continuously illuminated whenever the warning system is active.**
- 05 **If any red lights in addition to the continuously-illuminated red light that is required in Paragraph 4 of this Section are provided on the automatic pedestrian gate arm, they shall be installed in pairs and shall be flashed alternately in unison with the other flashing-light units at the crossing.**

Option:

- 06 The red light on an automatic pedestrian gate arm may be omitted if the pathway or sidewalk grade crossing is located within 25 feet of the traveled way at a highway-rail or highway-LRT grade crossing that is equipped with active warning devices (see Figure 8E-11).

Guidance:

- 07 *If used at a pathway or sidewalk grade crossing, the height of the automatic pedestrian gate arm when in the down position should be a minimum of 3 feet and a maximum of 4 feet above the pathway or sidewalk.*
- 08 *If used at a pathway or sidewalk grade crossing, the gate configuration, which might include a combination of automatic pedestrian gates and swing gates, should provide for full-width coverage of the pathway or sidewalk on each approach to the crossing.*

Standard:

- 09 **Where a sidewalk is located between the edge of a roadway and the support for an automatic gate arm that extends across the sidewalk and into the roadway, the location, placement, and height prescribed for vehicular gates shall be used (see Section 8D.03).**

Guidance:

- 10 *Except as provided in Paragraph 11 of this Section, if a separate automatic pedestrian gate is used for a sidewalk at a highway-rail or highway-LRT grade crossing, instead of a supplemental or auxiliary gate arm installed as a part of the same mechanism as the vehicular gate, a separate mechanism (see Figure 8E-11) should be provided for the separate automatic pedestrian gate so that if a pedestrian manually raises the pedestrian gate arm, it will have no effect on the vehicular gate.*

Option:

- 11 A supplemental or auxiliary pedestrian gate arm installed as a part of the same mechanism as the vehicular gate may be used if the operating mechanism is designed to prevent the vehicular gate from being raised as a result of a pedestrian manually raising the pedestrian gate arm.

- 12 A horizontal hanging bar (see Figure 8E-12) may be attached to an automatic pedestrian gate at a pathway or sidewalk grade crossing to inform pedestrians with vision disabilities that the automatic pedestrian gate is in the down position and to reduce the likelihood that pedestrians will violate a lowered crossing gate.

Guidance:

- 13 If a horizontal hanging bar is attached to an automatic pedestrian gate, the height of the horizontal hanging bar when in the down position should be a maximum of 26 inches above the pathway or sidewalk.

Section 8E.10 Active Traffic Control Devices – Multiple-Track Pathway or Sidewalk Grade Crossings

Guidance:

- 01 Where railroad or LRT tracks are immediately adjacent to other tracks, the traffic control devices that control pedestrian movements should be designed to avoid having pedestrians wait between sets of tracks.

Figure 8E-12. Example of an Automatic Pedestrian Gate with a Horizontal Hanging Bar at a Pathway or Sidewalk Grade Crossing

